



ATHENA[®]

Lincolnshire, UK

HOTEL 2018

1ST EDITION





YOUR PASSIONATE PARTNER IN HORECA



NEW CASUAL FINE DINING IS A HOT TOPIC. CHEFS LEAD THE TRENDS
OF FOOD ART, BUT NOT FORCE IT TO THE GUEST, THEY LISTEN AND
OBSERVE WHAT ARE LIKED. THEY TRANSFORM THE GUEST'S
EXPECTATION INTO PRESENTATION WITH OWN SIGNATURES.

THE DYNAMIC GOES ON, EXPECTATION GOES UP, AS A TREND SETTER,
ATHENA ADDED AN ARRAY OF BEAUTIFULLY CRAFTED DINING AND
BUFFET WARE FEATURING FRESH ELEMENTS FROM NATURE, VINTAGE
TOUCH FROM HOME, RUSTIC FEEL FROM COUNTRY SIDE...
ALL AIMED TO PROVIDE CHEFS WITH CHOICES FOR CREATION
IN THIS VOLATILE PLAYGROUND.

ATHENA CREATES ITEMS SPEAKING UNIQUE ACCENTS. HOPEFULLY YOU
WILL SEE OUR WORK DONE WITH CHEFS OVER THE YEARS ACROSS THE
CONTINENTS. WE STAND FIRM ON QUALITY, WE DEVOTE TO PRODUCT
DEVELOPMENT, WE TREASURE CUSTOMER'S FEEDBACK.

WE DON'T SEE BORDERS ON CREATION, BUT WE NEED COMPANIONS TO
GO THROUGH THE BOREDOM OF OLD FASHIONED FOOD DISPLAY.
PLEASE SET OUT TO EXPLORE THE NEXT HORIZON, HAND IN HAND WITH
THIS PARTNER – ATHENA. WE ARE ALWAYS AT YOUR SERVICE.

ATHENA

————— *solutions with passion* —————



CONTENT

FLATWARE	2
SPECIALTY DINING	40
TABLETOP	62
BUFFET DISPLAY	74
COFFEE & TEA	164
COCKTAIL & BARWARE	178
SERVICE & ROOM	188



FLATWARE

ATHENA PROVIDES COLLECTIONS OF STAINLESS STEEL FLATWARE WITH CHOICES OF DIFFERENT POLISHING TO BRIGHTEN UP THE DINING ATMOSPHERE FROM SMART CASUAL TO SIMPLE ELEGANCE. MIRROR, SATIN, VINTAGE AND PVD COLORING AT YOUR CHOICE.

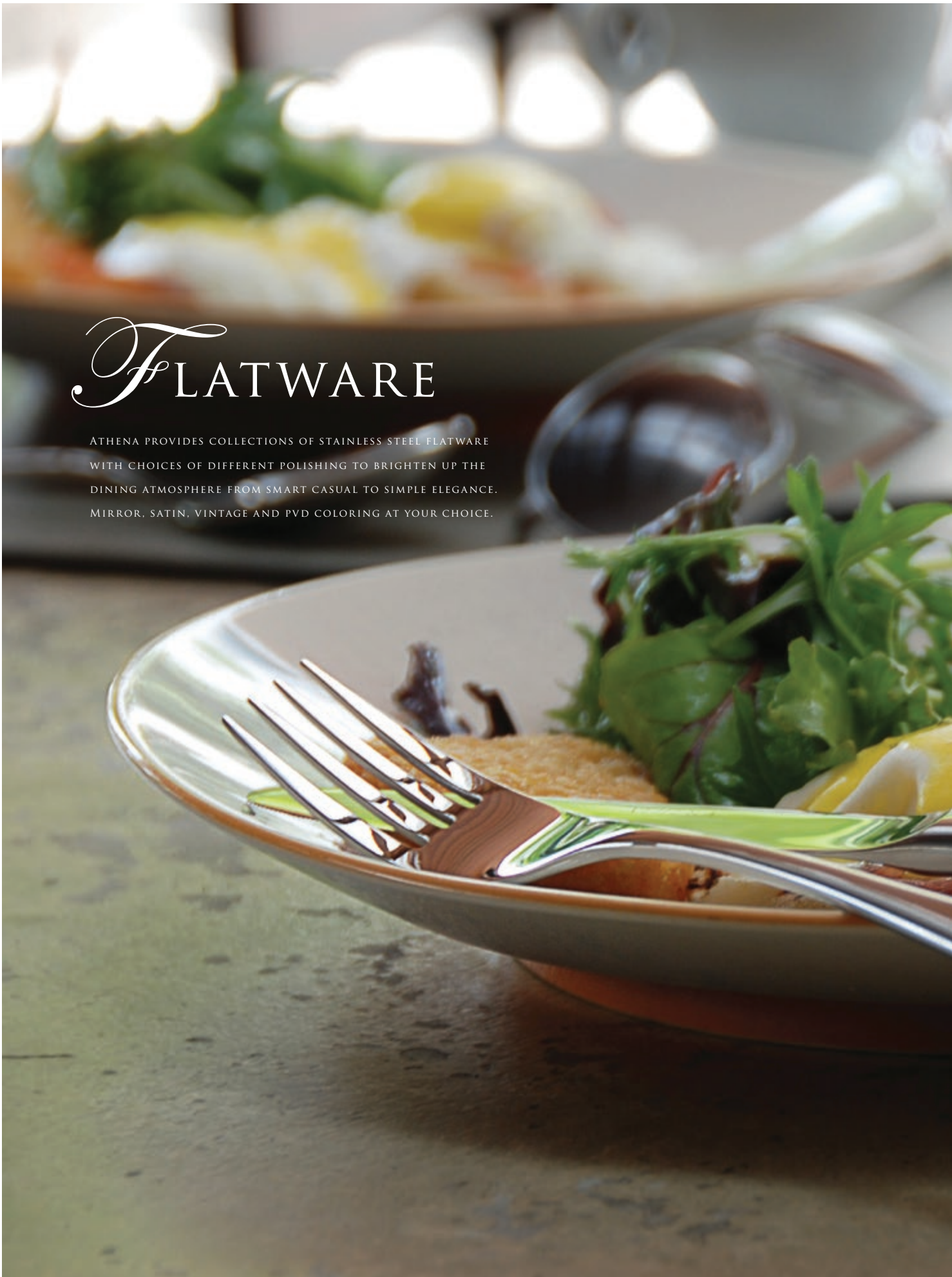



MIRROR POLISH

SHINY AND ELEGANT.

EXTRA CARE REQUIRED TO KEEP LONG LASTING LUSTRE.

MATT POLISH

SILKY AND SMOOTH. EASIER TO HANDLE.
FINGER PRINTS PROOF.

VINTAGE POLISH

SOLID AND AGED TEXTURE. EASY TO HANDLE. VIRTUALLY SCRATCH PROOF.



ROSE GOLD

FLATWARE



WHAT IS PVD?

PHYSICAL VAPOUR DEPOSITION (PVD)

IS AN ECO-FRIENDLY VACUUM COATING PROCESS THAT IS WIDELY APPLIED ON DIFFERENT CATERGORIES OF PRODUCTS SUCH AS JEWELRY, DOOR HARDWARE, CAR ACCESSORIES AND MARINE FITTINGS.

MATT ROSE GOLD



NOW, WE BRING IT ONTO TABLEWARE TO PROVIDE BRILLIANT AND DURABLE
DECORATIVE FINISH WITH EXCELLENT WEAR AND CORROSION RESISTANCE.
IT IS NOT EASY TO CHIP, FADE, CORRODE OR TARNISH AND MOST IMPORTANTLY,
IT IS FOOD SAFE.



VINTAGE ROSE GOLD



HOW IS PVD PROCESSED?

PHYSICAL VAPOUR DEPOSITION (PVD)

IS A PROCESS TO PRODUCE A METAL VAPOUR TO DEPOSIT ON THE TABLEWARE SURFACE AS A THIN BUT HIGHLY ADHERED PURE METAL OR ALLOY COATING.

THE COLOR IS DETERMINED BY THE CONTENT OF METAL OXIDE. THE PROCESS IS CARRIED OUT IN A VACUUM CHAMBER SO THAT THE METAL LAYER FORMED IS GUARANTEED TO BE PURE.

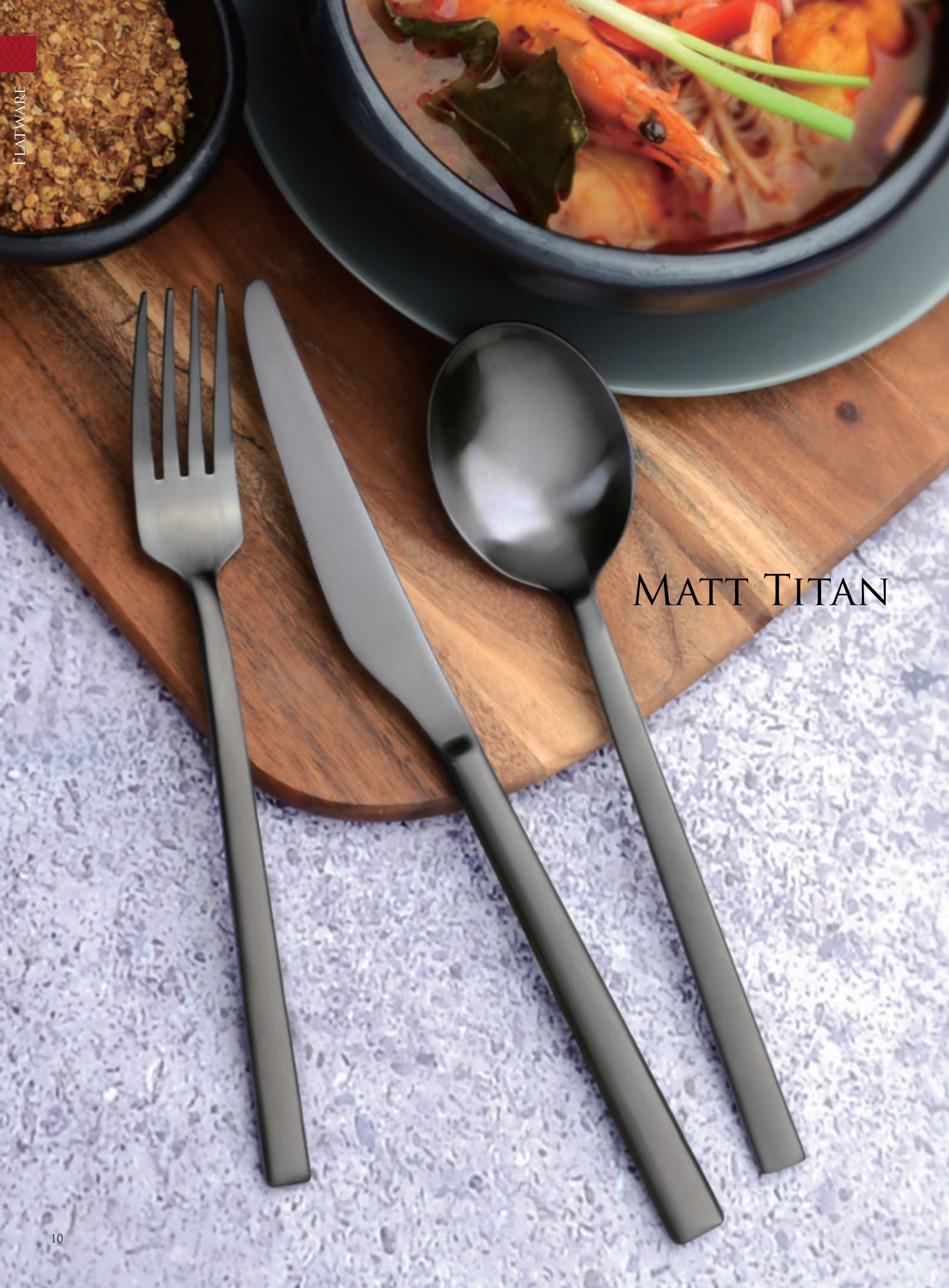

MATT TITAN

VINTAGE TITAN



HOW TO KEEP PVD TABLEWARE IN GOOD LUSTER?

PHYSICAL VAPOUR DEPOSITION (PVD)

PROCESSED TABLEWARE CAN BE USED, WASHED AND STORED AS NORMAL STAINLESS STEEL CULTERY. CARE APPLIED TO STAINLESS STEEL CULTERY ALSO APPLY TO PVD CULTERY.

IT IS DISHWASHER SAFE AND FOOD SAFE.



BRIGHT GOLD

MATT GOLD

FLATWARE





VINTAGE GOLD

CHOCO



MATT CHOCO



A set of vintage flatware, including a spoon, a fork, and a knife, arranged on a white lace doily. The pieces have a warm, metallic finish, likely copper or brass, and a simple, elegant design. The background is a dark, textured surface.

VINTAGE CHOCO



HUGO 808

DESIGN 808

4.0 MM GAUGE
HIGH MIRROR POLISH
MONO BLOCK KNIFE



808-SK/ STEAK KNIFE/ 240MM



808-TK/ TABLE KNIFE/ 240MM



808-TF/ TABLE FORK/ 200MM



808-TS/ TABLE SPOON/ 202MM



808-SS/ SOUP SPOON/ 181MM



808-BK/ BUTTER KNIFE/ 170MM



808-FK/ FISH KNIFE/ 206MM



808-FF/ FISH FORK/ 185MM



808-DK/ DESSERT KNIFE/ 218MM



808-DF/ DESSERT FORK/ 185MM



808-DS/ DESSERT SPOON/ 187MM



808-ITS/ ICE TEA SPOON/ 210MM



808-ET/ TEA SPOON/ 142MM



808-CS/ COFFEE SPOON/ 110MM



808-CF/ CAKE FORK/ 141MM



JOSSI 809

DESIGN 809

4.0 MM GAUGE
HIGH MIRROR POLISH
MONO BLOCK KNIFE



809-SK/ STEAK KNIFE/ 224MM



809-TK/ TABLE KNIFE/ 225MM



809-TF/ TABLE FORK/ 204MM



809-TS/ TABLE SPOON/ 205MM



809-SS/ SOUP SPOON/ 182MM



809-BK/ BUTTER KNIFE/ 163MM



809-FK/ FISH KNIFE/ 210MM



809-FF/ FISH FORK/ 186MM



809-DK/ DESSERT KNIFE/ 205MM



809-DF/ DESSERT FORK/ 186MM



809-DS/ DESSERT SPOON/ 185MM



809-ITS/ ICE TEA SPOON/ 210MM



809-ET/ TEA SPOON/ 144MM



809-CS/ COFFEE SPOON/ 112MM



809-CF/ CAKE FORK/ 144MM



ZENA 710

DESIGN 710

5.0 MM GAUGE
HIGH MIRROR POLISH
MONO BLOCK KNIFE



710-SK/ STEAK KNIFE/ 244MM



710-TK/ TABLE KNIFE/ 244MM



710-TF/ TABLE FORK/ 209MM



710-TS/ TABLE SPOON/ 206MM



710-SS/ SOUP SPOON/ 178MM



710-BK/ BUTTER KNIFE/ 170MM



710-FK/ FISH KNIFE/ 207MM



710-FF/ FISH FORK/ 186MM



710-DK/ DESSERT KNIFE/ 218MM



710-DF/ DESSERT FORK/ 186MM



710-DS/ DESSERT SPOON/ 185MM



710-ITS/ ICE TEA SPOON/ 212MM



710-ET/ TEA SPOON/ 145MM



710-CS/ COFFEE SPOON/ 110MM



710-CF/ CAKE FORK/ 145MM



BERNILI 707

DESIGN 707

5.0 MM GAUGE
HIGH MIRROR POLISH
MONO BLOCK KNIFE



-  707-SSK/ STANDING STEAK KNIFE/ 242MM
-  707-STK/ STANDING TABLE KNIFE/ 242MM
-  707-TK/ TABLE KNIFE/ 244MM
-  707-TF/ TABLE FORK/ 205MM
-  707-TS/ TABLE SPOON/ 202MM
-  707-SS/ SOUP SPOON/ 175MM
-  707-BK/ BUTTER KNIFE/ 170MM
-  707-FK/ FISH KNIFE/ 208MM
-  707-FE/ FISH FORK/ 185MM
-  707-SDK/ STANDING DESSERT KNIFE/ 218MM
-  707-DK/ DESSERT KNIFE/ 218MM
-  707-DF/ DESSERT FORK/ 185MM
-  707-DS/ DESSERT SPOON/ 182MM
-  707-ITS/ ICE TEA SPOON/ 210MM
-  707-ET/ TEA SPOON/ 143MM
-  707-CS/ COFFEE SPOON/ 110MM
-  707-CF/ CAKE FORK/ 143MM

^ STANDING STYLE STEAK KNIFE, TABLE KNIFE & DESSERT KNIFE ALSO AVAILABLE.



ANGELINA 706

DESIGN 706

6.0 MM GAUGE
HIGH MIRROR POLISH
MONO BLOCK KNIFE



706-SK/ STEAK KNIFE/ 244MM



706-TK/ TABLE KNIFE/ 244MM



706-TF/ TABLE FORK/ 214MM



706-TS/ TABLE SPOON/ 217MM



706-SS/ SOUP SPOON/ 182MM



706-BK/ BUTTER KNIFE/ 176MM



706-FK/ FISH KNIFE/ 218MM



706-FF/ FISH FORK/ 189MM



706-DK/ DESSERT KNIFE/ 220MM



706-DF/ DESSERT FORK/ 189MM



706-DS/ DESSERT SPOON/ 191MM



706-ITS/ ICE TEA SPOON/ 210MM



706-ET/ TEA SPOON/ 145MM



706-CS/ COFFEE SPOON/ 113MM



706-CF/ CAKE FORK/ 147MM



SAVADO 709

DESIGN 709

5.0 MM GAUGE
HIGH MIRROR POLISH
MONO BLOCK KNIFE



709-SSK/ STANDING STEAK KNIFE/ 246MM



709-STK/ STANDING TABLE KNIFE/ 242MM



709-TK/ TABLE KNIFE/ 244MM



709-TF/ TABLE FORK/ 205MM



709-TS/ TABLE SPOON/ 203MM



709-SS/ SOUP SPOON/ 180MM



709-BK/ BUTTER KNIFE/ 180MM



709-FK/ FISH KNIFE/ 223MM



709-FF/ FISH FORK/ 187MM



709-SDK/ STANDING DESSERT KNIFE/ 217MM



709-DK/ DESSERT KNIFE/ 217MM



709-DF/ DESSERT FORK/ 187MM



709-DS/ DESSERT SPOON/ 184MM



709-ITS/ ICE TEA SPOON/ 210MM



709-ET/ TEA SPOON/ 143MM



709-CS/ COFFEE SPOON/ 110MM



709-CF/ CAKE FORK/ 144MM

^ STANDING STYLE STEAK KNIFE, TABLE KNIFE & DESSERT KNIFE ALSO AVAILABLE.



CHESA 848

DESIGN 848

5.0 MM GAUGE
HIGH MIRROR POLISH
MONO BLOCK KNIFE



848-SK#2/ STEAK KNIFE/ 242MM



848-TK#2/ TABLE KNIFE/ 242MM



848-TF/ TABLE FORK/ 208MM



848-TS/ TABLE SPOON/ 206MM



848-SS/ SOUP SPOON/ 180MM



848-BK#2/ BUTTER KNIFE/ 170MM



848-FK/ FISH KNIFE/ 208MM



848-FF/ FISH FORK/ 183MM



848-DK#2/ DESSERT KNIFE/ 210MM



848-DF/ DESSERT FORK/ 183MM



848-DS/ DESSERT SPOON/ 182MM



848-ITS/ ICE TEA SPOON/ 208MM



848-ET/ TEA SPOON/ 140MM



848-CS/ COFFEE SPOON/ 115MM



848-CF/ CAKE FORK/ 141MM



ROYCE 806

DESIGN 806

5.0 MM GAUGE
HIGH MIRROR POLISH
MONO BLOCK KNIFE



806-SK#2/ STEAK KNIFE/ 241MM



806-TK#2/ TABLE KNIFE/ 240MM



806-TF/ TABLE FORK/ 200MM



806-TS/ TABLE SPOON/ 198MM



806-SS/ SOUP SPOON/ 178MM



806-BK/ BUTTER KNIFE/ 170MM



806-FK/ FISH KNIFE/ 205MM



806-FF/ FISH FORK/ 183MM



806-DK#2/ DESSERT KNIFE/ 210MM



806-DF/ DESSERT FORK/ 180MM



806-DS/ DESSERT SPOON/ 180MM



806-ITS/ ICE TEA SPOON/ 210MM



806-ET/ TEA SPOON/ 140MM



806-CS/ COFFEE SPOON/ 110MM



806-CF/ CAKE FORK/ 142MM



VINCI 805

DESIGN 805

4.0 MM GAUGE
HIGH MIRROR POLISH
MONO BLOCK KNIFE



805-SK#2/ STEAK KNIFE/ 240MM



805-TK#2/ TABLE KNIFE/ 240MM



805-TF/ TABLE FORK/ 201MM



805-TS/ TABLE SPOON/ 204MM



805-SS/ SOUP SPOON/ 178MM



805-BK#2/ BUTTER KNIFE/ 180MM



805-FK/ FISH KNIFE/ 204MM



805-FF/ FISH FORK/ 181MM



805-DK#2/ DESSERT KNIFE/ 210MM



805-DF/ DESSERT FORK/ 181MM



805-DS/ DESSERT SPOON/ 184MM



805-ITS/ ICE TEA SPOON/ 208MM



805-ET/ TEA SPOON/ 145MM



805-CS/ COFFEE SPOON/ 115MM



805-CF/ CAKE FORK/ 148MM

STEAK KNIVES & SUPPLEMENT

SHAPE, BOLSTER, BLADE, AND MATERIAL OF HANDLE DEFINE THE FORM OF A STEAK KNIFE WHILE GOOD WORKMANSHIP ADDS VALUE TO IT. CHOOSE YOUR FAVOURITE STEAK KNIFE TO MATCH YOUR CUISINE AND MOOD.



LACROX

DELUXE STEAK KNIVES,
FULL TANG FORGED, FEATURED WITH
SELECTED HANDLE MATERIAL.



- 1 LACROX STEAK FORK/ SF-06-EB
210 MM LENGTH
- 2 LACROX STEAK KNIFE/ SK-06-EB
BLADE: 120MM OVERALL: 242MM
EBONY COLOUR
PAKKA WOOD HANDLE



- 1 LACROX STEAK FORK/ SF-06-TU
210 MM LENGTH
- 2 LACROX STEAK KNIFE/ SK-06-TU
BLADE: 120MM OVERALL: 242MM
TURTLE COLOUR
ACRYLIC HANDLE



- 1 LACROX STEAK FORK/ SF-06-MA
210 MM LENGTH
- 2 LACROX STEAK KNIFE/ SK-06-MA
BLADE: 120MM OVERALL: 242MM
MARRON COLOUR
PAKKA WOOD HANDLE



- 1 LACROX STEAK FORK/ SF-06-IV
210 MM LENGTH
- 2 LACROX STEAK KNIFE/ SK-06-IV
BLADE: 120MM OVERALL: 242MM
IVORY COLOUR
ACRYLIC HANDLE



- 1 LACROX STEAK FORK/ SF-06-PI
210 MM LENGTH
- 2 LACROX STEAK KNIFE/ SK-06-PI
BLADE: 120MM OVERALL: 242MM
PISTACHE COLOUR
PAKKA WOOD HANDLE



- 1 LACROX STEAK FORK/ SF-06-OL
210 MM LENGTH
- 2 LACROX STEAK KNIFE/ SK-06-OL
BLADE: 120MM OVERALL: 242MM
OLIVE COLOUR
PAKKA WOOD HANDLE

AMARI

DELUXE STEAK KNIVES, FULL TANG,
HIGH MIRROR POLISHED, FEATURED WITH
SELECTED HANDLE MATERIAL.



AMARI STEAK KNIFE/ SK-08-IV
BLADE: 114MM **DISCONTINUED**
IVORY COLOUR
ACRYLIC HANDLE



AMARI STEAK KNIFE/ SK-08-BK
BLADE: 114MM **DISCONTINUED**
GLOSSY BLACK
ACRYLIC HANDLE



AMARI STEAK KNIFE/ SK-08-MA
BLADE: 114MM **DISCONTINUED**
MARRON COLOUR
PAKKA WOOD HANDLE



AMARI STEAK KNIFE/ SK-08-EB
BLADE: 114MM **DISCONTINUED**
EBONY COLOUR
PAKKA WOOD HANDLE



AMARI STEAK KNIFE/ SK-08-PI
BLADE: 114MM **DISCONTINUED**
PISTACHE COLOUR
PAKKA WOOD HANDLE



AMARI STEAK KNIFE/ SK-08-OL
BLADE: 114MM **DISCONTINUED**
OLIVE COLOUR
PAKKA WOOD HANDLE

POSH

ATHENA CLASSIC DESIGN STEAK KNIVES



POSH II STEAK KNIFE/ SK-04
BLADE: 113MM OVERALL: 227MM
ABS HANDLE



POSH II STEAK KNIFE/ SK-03
BLADE: 113MM OVERALL: 227MM
DARK BROWN
PAKKA WOOD HANDLE



POSH I STEAK KNIFE/ SK-05
BLADE: 113MM **DISCONTINUED**
STEEL HANDLE



SUPPLEMENT CUTLERY



GRANDE PLUS BRIDAL KNIFE
GP-52BR/ BLADE: 240MM/ OVERALL: 370MM



LOBSTER FORK
826-SES/ 205MM



LOBSTER CRACKER
TB-01/ 157MM



OYSTER FORK
805-OF/ 130MM



CAVIAR SCRAPER
CVK-01/ 110MM



CAVIAR SPOON
CVS-01/ 115MM



SPECIALTY DINING

ATHENA OFFERS A RANGE OF DESIGNER TABLEWARE WHICH TURNS YOUR SMALL BITES INTO GREAT ONES. AVAILABLE IN RUSTIC WOOD, PORCELAIN, GLASS, SLATE AND METAL – MIX & MATCH TO CREATE UNLIMITED STYLES OF PRESENTATION.



ARROW EDGE
FOR EASY LIFTING

DIP PLATE SET/ CB-43.2, CONSISTING OF:
- WOODEN PLATE/ 180x362MM
- GH-14 SAUCE BOWL/ Ø70x40(H)MM



ARROW EDGE
FOR EASY LIFTING

DIP PLATE SET/ CB-42.2, CONSISTING OF:
- WOODEN PLATE/ 255x362MM
- GH-14 SAUCE BOWL/ Ø70x40(H)MM



DIP PLATE SET/ CB-45.2, CONSISTING OF:
- WOODEN PLATE/ 102x300MM
- GH-12 SAUCE BOWL/ Ø80x30(H)MM



DIP PLATE SET/ CB-44.4, CONSISTING OF:
- WOODEN PLATE/ **DISCONTINUED**
- 3PCS OF GH-12 SAUCE BOWL/
Ø80x30(H)MM



DIP PLATE SET/ CB-51.4, CONSISTING OF:
- WOODEN PLATE/ 205x300MM
- 3PCS OF GH-12 SAUCE BOWL/
Ø80x30(H)MM



ARROW EDGE
FOR EASY LIFTING

RELISH SET/ CB-46.4, CONSISTING OF:
- WOODEN PLATE/ 144x338MM
- 3PCS OF GH-13 RELISH BOWL/
Ø90x42(H)MM



TAPAS SET/ CB-63.4, CONSISTING OF:
- TOKYO WOODEN TRAY/ **DISCONTINUED**
305x105x20(H)MM
- 3PCS OF GH-19 CORTE PORCELAIN
BOWL/ 120x75x50(H)MM



TAPAS SET/ CB-62.6, CONSISTING OF:
- DELHI WOODEN TRAY/ **DISCONTINUED**
Ø235x20(H)MM
- 5PCS OF GH-46 DOLCE S/S BOWL/
90x60x35(H)MM



ASHLEY

PADDLE BOARDS WITH HANDY DESIGN,
MADE OF WARM ACACIA, DEVOTED TO
THE BEST PRESENTATION OF TAPAS AND PLATTERS.

PADDLE SERVING BOARD



CB-86/ DISCONTINUED M



CB-85/ DISCONTINUED M



CB-84/ DISCONTINUED M



CB-90/ DISCONTINUED M



CB-92/ DISCONTINUED



CB-91/ DISCONTINUED



TOMAHAWK SERVING BOARD SET /
CB-81.3, CONSISTING OF:
- PORCELAIN PLATE / 380X230MM
- WOODEN BOARD / 430X250MM WITH METAL RING



SERVING BOARD SET / CB-88.2,
CONSISTING OF:
- SLATE PLATE / 530X330MM
- WOODEN BOARD / 575X375MM



SERVING BOARD SET / CB-79.2, CONSISTING OF:
 - SLATE PLATE / 480x230MM
 - WOODEN BOARD / 520x272MM



SERVING BOARD SET / CB-87.2, CONSISTING OF:
 - SLATE PLATE / 315x155MM
 - WOODEN BOARD / 360x200MM



ASHLEY SERVING BOARD SET



SERVING BOARD SET / TR-2201.2,
CONSISTING OF:
- SLATE PLATE / Ø250 X 8(H)MM
- WOODEN BOARD / Ø290 X 40(H)MM



SERVING BOARD SET / TR-2202.2,
CONSISTING OF:
- SLATE PLATE / Ø300 X 8(H)MM
- WOODEN BOARD / Ø340 X 40(H)MM



SERVING BOARD SET / TR-2203.2,
CONSISTING OF:
- SLATE PLATE / Ø350 X 8(H)MM
- WOODEN BOARD / Ø390 X 40(H)MM

NORDICA



NORDICA SEAFOOD TOWER / BU-38.5 CONSISTING OF:

- BU-38 SEAFOOD PLATTER / Ø345×50(H)MM
- BU-37 SEAFOOD PLATTER / Ø305×50(H)MM
- BU-36 SEAFOOD PLATTER / Ø250×40(H)MM
- RI-12.200R.155 RISER / Ø200×155(H)MM
- RI-12.180R.130 RISER / Ø180×130(H)MM

NORDICA SEAFOOD PLATTER



SEAFOOD PLATTER SET, LARGE / BU-38.3 CONSISTING OF:

- BU-38 SEAFOOD PLATTER / Ø345×50(H)MM
 - BU-37 SEAFOOD PLATTER / Ø305×50(H)MM
 - RI-12.200R.155 RISER / Ø200×155(H)MM
- (SAUCE BOWL AND SPOON NOT INCLUDED)



SEAFOOD PLATTER SET, SMALL / BU-37.3 CONSISTING OF:

- BU-37 SEAFOOD PLATTER / Ø305×50(H)MM
 - BU-36 SEAFOOD PLATTER / Ø250×40(H)MM
 - RI-12.180R.130 RISER / Ø180×130(H)MM
- (SAUCE BOWL AND SPOON NOT INCLUDED)



NATURAL SLATE

FOOD SAFE-LAMINATED NATURAL SLATE
PERFECT FOR PETIT FOUR, TASTING MENU,
SNACK, SUSHI & BUFFET.



TASTING MENU

TREND OF THE MOMENT. ATHENA OFFERS A RANGE OF MINIATURES PROVIDING UNLIMITED SOLUTIONS FOR FOOD PRESENTATION.



FEATURING ^ :

- ① GW-205 KUBA SQUARE BOWL/ 60×60×52(H)MM
- ② GW-601.06 ZOIE GOURMET GLASS/ 0.06L
- ③ GW-304.08 ZOIE GOURMET JAR/ 0.08L
- ④ 848-CS CHESA COFFEE SPOON/ 115MM
- ⑤ NS-300120.08 NATURAL SLATE/ 300×120×8MM



FEATURING ^ :

- ① GW-602.12 DAPHNE GOURMET GLASS/ 0.12L
- ② 848-SSP CHESA SNACK SPOON/ 147MM
- ③ NS-200200.08 NATURAL SLATE/ 200×200×8MM



FEATURING ^ :

- ① CW-101.10 CORTE MINI JUG/ 0.1L
- ② CW-002 CORTE ROUND BOWL/ Ø90×40(H)MM
- ③ CW-001 KUBA SQUARE BOWL/ 60×60×52(H)MM
- ④ NS-300120.08 NATURAL SLATE/ 300×120×8MM

^ MORE DETAILS OF MINIATURES ARE AVAILABLE ON P. 60, 61 & 113



NS-200100.08/ 200×100×8MM



NS-300120.08/ 300×120×8MM



NS-400120.08/ 400×120×8MM



NS-300200.08/ 300×200×8MM



NS-200200.08/ 200×200×8MM



NS-300300.08/ 300×300×8MM



NS-250R.08 / Ø250×8MM



NS-300R.08 / Ø300×8MM

NATURAL SLATE IS A HAND CRAFTED PRODUCT, ABOVE SIZES AND THICKNESSES MAY VARY

OLD FARMER

RUSTIC BOARD IS INSPIRED FROM THE VILLAGE FARMHOUSE. THEY ARE CHARMING AND HOMEY, PERFECT FOR SERVING PLATTERS AND MEATS. IT IS MADE OF NATURAL ACACIA WOOD WHICH IS FOOD SAFE, EASILY MAINTAINED AND KNIFE FRIENDLY. IT COMES IN VARIOUS THOUGHTFUL SIZES COVERING ALL YOUR NEEDS.



OLD FARMER RUSTIC BOARD, DOUBLE SIDED



CB-68-A/ 220×220×20(H)MM
WITH RECESS FOR CORTE SAUCE BOWL GH-14



CB-69-A/ 420×120×20(H)MM
WITH RECESS FOR REECE MINI TUREEN CW-501



OLD FARMER RUSTIC BOARD



CB-70-A/ 300×300×25(H)MM



CB-71-A/ 360×240×25(H)MM



CB-72-A/ 360×360×25(H)MM

HORIZON & LUNA

A LOVELY PRESENTATION OF LAYERED FINE FOOD



HORIZON DOUBLE WALL GOURMET GLASS *Handmade*



GDG-06.04/ DISCONTINUED



GDG-06.08/ DISCONTINUED



GDG-06.18/ DISCONTINUED

LUNA DOUBLE WALL GOURMET GLASS *Handmade*



GDG-05.04/ DISCONTINUED



GDG-05.08/ DISCONTINUED



GDG-05.18/ DISCONTINUED



GRANA

INSPIRED BY ASIAN CULINARY, ATHENA MARBLE BOWLS ARE PERFECT FOR PRESENTING FUSION FINE FOOD. THE GIFTED NATURAL PATTERN VARIES FROM ONE TO OTHERS, CREATING IRRESISTIBLE UNIQUENESS TO TABLE ART.

MARBLE BOWL

NEW



MA-101/ Ø50×25(H)MM

NEW



MA-102/ Ø50×50(H)MM

NEW



MA-103/ Ø60×60(H)MM

NEW



MA-104/ Ø80×40(H)MM

NEW



MA-105/ Ø90×50(H)MM

NEW



MA-106/ Ø130×52(H)MM

NEW



MA-107/ Ø170×55(H)MM



LA TAPAS

PRODUCED FROM THE GIFTED NATURAL BLACK CLAY FROM SOUTH AMERICA. EXPRESSING PURE BEAUTY THROUGH THEIR RUGGED SHAPES AND OUTLINES. EACH PIECE IS HAND CRAFTED WITH ORIGINAL WORKMANSHIP.

MINI ROUND DISH



A-925810 / DISCONTINUED

MINI ROUND DISH W/ BASE



A-925806 / DISCONTINUED

MINI POT W/ HANDLE & LID



A-925809 / DISCONTINUED

BOWL W/ HANDLE



A-925801 / DISCONTINUED

ROUND DISH



A-925002 / DISCONTINUED



A-925005 / DISCONTINUED

ROUND DISH W/ HANDLE



A-925104 / DISCONTINUED

ROUND POT W/LID



A-925211 / DISCONTINUED

CORTE PORCELAIN BOWL



GH-57/ Ø50×25(H)MM
GH-14/ Ø70×40(H)MM



GH-12/ Ø80×30(H)MM



GH-13/ Ø90×42(H)MM



GH-19/ 120×75×50(H)MM

CORTE PORCELAIN BOWL, MATT BLACK



GH-57-MBLK/ Ø50×25(H)MM
GH-14-MBLK/ Ø70×40(H)MM



GH-12-MBLK/ Ø80×30(H)MM



GH-13-MBLK/ Ø90×42(H)MM



GH-19-MBLK/ 120×75×50(H)MM

CROWN BREAD BASKET



GH-42/ 197×140×85(H)MM



GH-04/ **DISCONTINUED**

CASPER BREAD BOX



TR-1601-AS/ 180×180×75(H)MM

RING BREAD BASKET



GH-56/ Ø200×66(H)MM

TAPAS SET



CB-63.4/ **DISCONTINUED M**
WITH 3PCS OF GH-19 CORTE PORCELAIN BOWL

MINI PAIL W/BASE



PB-130130/ Ø130×130(H)MM
STAINLESS STEEL HANDLED

LE FON

THE RANGE OF MINI COOKWARE RESEMBLING OLD FRENCH STYLE,
BRINGING NEW DIMENSION TO THE FUSION GOURMET.



LE FON MINI FRY PAN



LF-10525-BH/ Ø105×25(H)MM



LF-20538-BH/ Ø205×38(H)MM



LE FON MINI SAUCE PAN

LE FON MINI POT



LF-10045-BH / Ø100×45(H)MM



LF-8570-DBH/ Ø85×70(H)MM



LF-12585-DBH/ Ø125×85(H)MM

DELI

THERE ARE NEVER TOO MUCH TAPAS –
FOOD SHARING BRINGS FUN TO THE TABLE.
TRY THIS RANGE OF TAPAS WOK WITH GOLDEN HANDLES.



DELI PAN W/ DOUBLE HANDLES



DE-12520-DGH/ Ø125×20(H)MM



DE-16026-DGH/ Ø160×26(H)MM



DE-20035-DGH/ Ø200×35(H)MM



DE-24040-DGH/ Ø240×40(H)MM



DE-28045-DGH/ Ø280×45(H)MM

FRENCH STYLE

MINI POTS AND PANS DESIGNED TO BRIGHTEN UP THE CHEF'S PRESENTATION OF FOOD ART WHILE ORGANIZING FOOD SERVING. TAKE A LOOK AND DISCOVER THE UNLIMITED COMBINATION YOU CAN CREATE FOR YOUR OWN STYLE.



MINI PAIL W/BASE



PB-7276/ **DISCONTINUED**
STAINLESS STEEL HANDLED



PB-9292/ **DISCONTINUED**
STAINLESS STEEL HANDLED



PB-130130/ **DISCONTINUED**
STAINLESS STEEL HANDLED

ROASTING PAN



RP-14595/ **DISCONTINUED**
STAINLESS STEEL HANDLED

MINI CONICAL SAUCE PAN



CSP-7050-BH/ **DISCONTINUED**
STAINLESS STEEL WITH
BRASS HANDLE



CSP-9060-BH/ **DISCONTINUED**
STAINLESS STEEL WITH
BRASS HANDLE

MINI SAUCE PAN



SP-9060-BH/ **DISCONTINUED**
STAINLESS STEEL WITH
BRASS HANDLE

MINI FRY PAN



FP-12035-BH/ **DISCONTINUED**
STAINLESS STEEL WITH
BRASS HANDLE

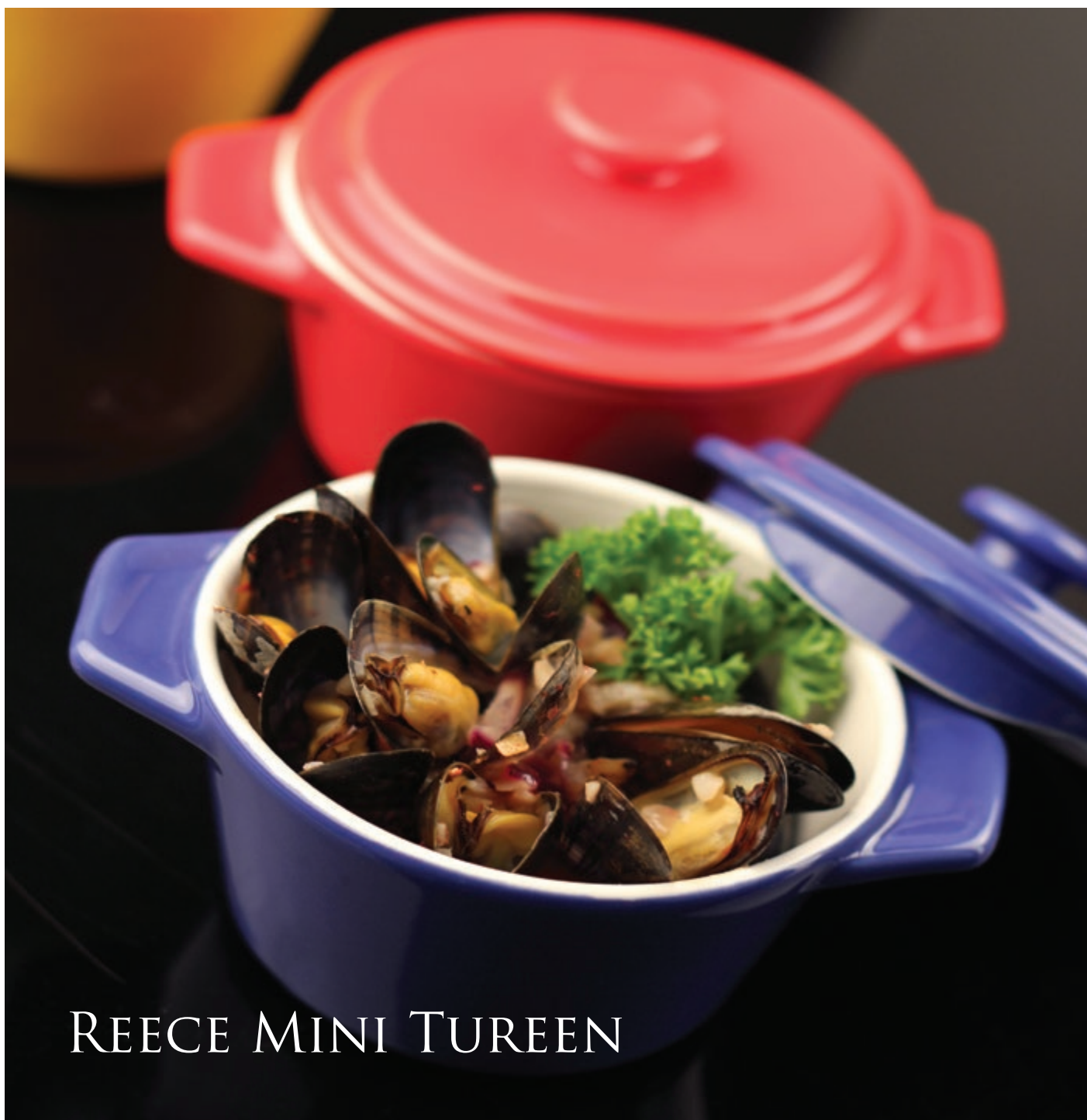

REECE MINI TUREEN

REECE MINI TUREEN/ Ø100x85(H)MM 0.20L



CW-501-CHO/ CHOCOLATE



CW-501-COB/ DISCONTINUED



CW-501-YEL/ YELLOW



CW-501-RED/ RED



FEATURING: ^

- ① 848-MSP/ CHESA MINI SPORK/ 120MM
- ② GW-602.08/ DAPHNE GOURMET GLASS/ 0.08L
- ③ CW-501-COB/ REECE MINI TUREEN/ COBALT/ Ø100x85(H)MM 0.2L

GOURMET BASKET

ATHENA GOURMET BASKETS
ARE THOUGHTFULLY
DESIGNED IN THE RIGHT
SIZES AND SHAPES TO REFINE
FOOD PRESENTATION.



GOURMET BASKET



TOP-18
BASKET: 94×78×78(H)MM
OVERALL: 199×78×120(H)MM



TOP-19
BASKET: 118×98×78(H)MM
OVERALL: 220×98×120(H)MM



TOP-20
BASKET: **DISCONTINUED**
OVERALL: 240×114×120(H)MM



TOP-21
BASKET: 160×102×50(H)MM
OVERALL: 258×102×80(H)MM



TOP-22
BASKET: Ø93×79(H)MM
OVERALL: 188×93×128(H)MM



MINIATURE GLASSES

THIS RANGE OF GOURMET GLASSES FURTHER ENHANCE THE COLOUR EFFECTS BROUGHT TO YOU BY THE CHEFS.

DAPHNE GOURMET GLASS



GW-602.04/ **DISCONTINUED**



GW-602.08/ **DISCONTINUED**



GW-602.12/ **DISCONTINUED**

DAPHNE GOURMET BOWL



GW-102/ ø86x46(H)MM

ZOIE GOURMET GLASS



GW-601.06/ **DISCONTINUED**



GW-603.12/ **DISCONTINUED**

DORF GOURMET GLASS



GSG-03.10/ 0.10L

LEXI GOURMET GLASS



GSG-01.10/ 0.10L

ZOIE GOURMET JAR



GW-303.06/ **DISCONTINUED**
MATCH WITH 848-CS



GW-304.08/ **DISCONTINUED**
MATCH WITH 848-CS



GW-305.10/ **DISCONTINUED**
MATCH WITH 848-CS

KUBA GOURMET GLASS



GW-204/ 40x40x40(H)MM
GW-205/ 60x60x52(H)MM

MINIATURE PORCELAIN

CHOICES OF SHAPES, SIZES AND COLOURS REALIZE
PERSONALITY THAT DELIVERS STYLE.



CORTE MINI JUG

NEW



CW-101.10/ 0.10L
CW-101.10-MBLK/ 0.10L

CORTE GOURMET SPOON



CW-701/ 142x36(H)MM

CORTE GOURMET BOWL

NEW



CW-005/ 95x70x35(H)MM

NEW



CW-006/ 110x95x48(H)MM

CORTE PORCELAIN BOWL



GH-57/ ø50x25(H)MM
GH-14/ ø70x40(H)MM



GH-12/ ø80x30(H)MM



GH-13/ ø90x42(H)MM



GH-19/ 120x75x50(H)MM

CORTE PORCELAIN BOWL, MATT BLACK



GH-57-MBLK/ ø50x25(H)MM
GH-14-MBLK/ ø70x40(H)MM



GH-12-MBLK/ ø80x30(H)MM



GH-13-MBLK/ ø90x42(H)MM



GH-19-MBLK/ 120x75x50(H)MM

CORTE ROUND BOWL/ ø90x40(H)MM



CW-002/ WHITE



CW-002-MBLK/ MATT BLACK

CHESA MINI SPORK



848-MSP/ **DISCONTINUED**

CHESA SNACK SPORK



848-SSP/ **DISCONTINUED**



TABLETOP

TABLETOP



CASSANDRA

ELEGANTLY DESIGNED CONDIMENT ACCESSORIES
FULFILLING ALL NEEDED BY AN ADD TABLE.

MARCUS OIL & VINEGAR BOTTLE



GW-202/ Ø58×188(H)MM

CASSANDRA OIL & VINEGAR BOTTLE WITH POURER & S/S CAP



GW-212/ 0.20L

CASSANDRA CREAM & SUGAR SET

NEW



FEATURING:

- ① TOP-90 WOODEN TRAY W/ S/S BOWLS/ 152×76×40(H)MM
- ② CW-103 MILK BOTTLE/ 0.18L
- ③ CW-104 SUGAR SACHET BOWL/ Ø58×80(H)MM

CASSANDRA CONDIMENT SET

NEW



FEATURING:

- ① TOP-87 WOODEN TRAY W/ S/S BOWLS & HANDLE/ 152×152×230(H)MM
- ② GW-212 OIL & VINEGAR BOTTLE/ 0.20L
- ③ PM-44.06 PEPPER MILL/ APPROX. 6" (H)
- ④ SM-44.06 SALT MILL/ APPROX. 6" (H)



TR-1002 TOKYO WOODEN TRAY / 186×93×20(H)MM

SALT & PEPPER

AVAILABLE IN DIFFERENT DESIGNS & MATERIALS,
MODERN & PRACTICAL.

SALT MILL



SM-41.06-DB/ **DISCONTINUED**
WITH CERAMIC GRINDER

PEPPER MILL



PM-41.06-DB/ **DISCONTINUED**
WITH CERAMIC GRINDER

SALT MILL



SM-41.06-B/ **DISCONTINUED**
WITH CERAMIC GRINDER

PEPPER MILL



PM-41.06-B/ **DISCONTINUED**
WITH CERAMIC GRINDER

SALT MILL



SM-42.06-DB/ **DISCONTINUED**
WITH CERAMIC GRINDER

PEPPER MILL



PM-42.06-DB/ **DISCONTINUED**
WITH CERAMIC GRINDER

SALT MILL



SM-42.06-B/ **DISCONTINUED**
WITH CERAMIC GRINDER

PEPPER MILL



PM-42.06-B/ **DISCONTINUED**
WITH CERAMIC GRINDER

SALT MILL



SM-43.06/ **DISCONTINUED**
WITH CERAMIC GRINDER

DISCONTINUED



PM-43.06/ **DISCONTINUED**
WITH CERAMIC GRINDER

SALT MILL



SM-44.06/ APPROX. 6"(H)
WITH CERAMIC GRINDER

PEPPER MILL



PM-44.06/ APPROX. 6"(H)
WITH CERAMIC GRINDER

SALT & PEPPER MILL SET



FEATURING:

- 1 SM-41.06-DB/ **DISCONTINUED**
- 2 PM-41.06-DB/ **DISCONTINUED**
- 3 TR-1002/ 186x93x20(H)MM

SALT & PEPPER MILL SET



FEATURING:

- 1 SM-42.06-B/ **DISCONTINUED**
- 2 PM-42.06-B/ **DISCONTINUED**
- 3 TR-1002/ 186x93x20(H)MM

SALT & PEPPER MILL SET



FEATURING:

- 1 SM-43.06/ **DISCONTINUED**
- 2 PM-43.06/ **DISCONTINUED**
- 3 TR-1002/ 186x93x20(H)MM

SALT & PEPPER MILL SET



FEATURING:

- 1 SM-44.06/ APPROX. 6" (H)
- 2 PM-44.06/ APPROX. 6" (H)
- 3 TR-1002/ 186x93x20(H)MM

KUBA

A RANGE IN NEATLY MATCHING SIZES
 FEATURING CHOICES OF DAILY REQUIRED
 CONDIMENT UTENSILS. NOW THESE LITTLE
 THINGS STAY IN PLACE WITH ELEGANT
 APPEARANCE AND BETTER HYGIENE.
 DIFFERENT COMBINATIONS AT YOUR
 CHOICES.



FEATURING:

- ① TOP-65 KUBA RECTANGULAR TRAY / 151x80x9(H)MM
- ② TOP-76 KUBA SUGAR SACHET HOLDER / 76x58x52(H)MM
- ③ SMJ.NM-02.20 SPHERES MILK JUG / 0.20L



FEATURING:

- ① TOP-65 KUBA RECTANGULAR TRAY / 151x80x9(H)MM
- ② TOP-76 KUBA SUGAR SACHET HOLDER / 76x58x52(H)MM
- ③ SMJ-03.20 MESSINA MILK JUG / 0.20L



FEATURING:

- ① TOP-65 KUBA RECTANGULAR TRAY / 151x80x9(H)MM
- ② TOP-63 KUBA SQUARE TRAY / 93x93x9(H)MM
- ③ TOP-65 KUBA RECTANGULAR TRAY / 151x80x9(H)MM
- ④ TOP-62 KUBA SUGAR SACHET HOLDER / 93x58x52(H)MM
- ⑤ SMJ.NM-02.20 SPHERES MILK JUG / 0.20L
- ⑥ SM-41.06-B SALT MILL / APPROX 6"(H) WITH CERAMIC GRINDER
- ⑦ PM-41.06-B PEPPER MILL / APPROX 6"(H) WITH CERAMIC GRINDER



FEATURING:

- ① TOP-65 KUBA RECTANGULAR TRAY / 151x80x9(H)MM
- ② TOP-63 KUBA SQUARE TRAY / 93x93x9(H)MM
- ③ TOP-65 KUBA RECTANGULAR TRAY / 151x80x9(H)MM
- ④ TOP-62 KUBA SUGAR SACHET HOLDER / 93x58x52(H)MM
- ⑤ SMJ-03.20 MESSINA MILK JUG / 0.20L
- ⑥ SM-41.06-B SALT MILL / APPROX 6"(H) WITH CERAMIC GRINDER
- ⑦ PM-41.06-B PEPPER MILL / APPROX 6"(H) WITH CERAMIC GRINDER



FEATURING:

- ① TOP-63 KUBA SQUARE TRAY / 93x93x9(H)MM
- ② TOP-63 KUBA SQUARE TRAY / 93x93x9(H)MM
- ③ TOP-63 KUBA SQUARE TRAY / 93x93x9(H)MM
- ④ TR-1002 TOKYO WOODEN TRAY / 186x93x20(H)MM
- ⑤ SSB-03.20 MESSINA SUGAR BOWL^ / 0.20L
- ⑥ TOP-64 KUBA VASE / 93x93x68(H)MM
- ⑦ SM-41.06-B SALT MILL / APPROX 6"(H) WITH CERAMIC GRINDER
- ⑧ PM-41.06-B PEPPER MILL / APPROX 6"(H) WITH CERAMIC GRINDER
- ⑨ SMJ-03.20 MESSINA MILK JUG / 0.20L



FEATURING:

- ① TOP-65 KUBA RECTANGULAR TRAY / 151x80x9(H)MM
- ② SM-41.06-B SALT MILL / APPROX 6"(H) WITH CERAMIC GRINDER
- ③ PM-41.06-B PEPPER MILL / APPROX 6"(H) WITH CERAMIC GRINDER



FEATURING:

- ① TR-1002 TOKYO WOODEN TRAY / 186x93x20(H)MM
- ② SM-41.06-B SALT MILL / APPROX 6"(H) WITH CERAMIC GRINDER
- ③ PM-41.06-B PEPPER MILL / APPROX 6"(H) WITH CERAMIC GRINDER



FEATURING:

- ① TOP-63 KUBA SQUARE TRAY / 93x93x9(H)MM
- ② TOP-63 KUBA SQUARE TRAY / 93x93x9(H)MM
- ③ TOP-62 KUBA SUGAR SACHET HOLDER / 93x58x52(H)MM
- ④ TOP-64 KUBA VASE / 93x93x68(H)MM
- ⑤ TR-1002 TOKYO WOODEN TRAY / 186x93x20(H)MM
- ⑥ SMJ.NM-02.20 SPHERES MILK JUG / 0.20L
- ⑦ SM-41.06-B SALT MILL / APPROX 6"(H) WITH CERAMIC GRINDER
- ⑧ PM-41.06-B PEPPER MILL / APPROX 6"(H) WITH CERAMIC GRINDER



FEATURING:

- ① TOP-63 KUBA SQUARE TRAY / 93x93x9(H)MM
- ② TOP-63 KUBA SQUARE TRAY / 93x93x9(H)MM
- ③ TOP-62 KUBA SUGAR SACHET HOLDER / 93x58x52(H)MM
- ④ TOP-64 KUBA VASE / 93x93x68(H)MM
- ⑤ TR-1002 TOKYO WOODEN TRAY / 186x93x20(H)MM
- ⑥ SMJ-03.20 MESSINA MILK JUG / 0.20L
- ⑦ SM-41.06-B SALT MILL / APPROX 6"(H) WITH CERAMIC GRINDER
- ⑧ PM-41.06-B PEPPER MILL / APPROX 6"(H) WITH CERAMIC GRINDER



FEATURING:

- ① TOP-63 KUBA SQUARE TRAY / 93x93x9(H)MM
- ② TOP-63 KUBA SQUARE TRAY / 93x93x9(H)MM
- ③ TOP-63 KUBA SQUARE TRAY / 93x93x9(H)MM
- ④ TR-1002 TOKYO WOODEN TRAY / 186x93x20(H)MM
- ⑤ SSB.NM-02.20 SPHERES SUGAR BOWL / 0.20L
- ⑥ TOP-64 KUBA VASE / 93x93x68(H)MM
- ⑦ SM-41.06-B SALT MILL / APPROX 6"(H) WITH CERAMIC GRINDER
- ⑧ PM-41.06-B PEPPER MILL / APPROX 6"(H) WITH CERAMIC GRINDER
- ⑨ SMJ.NM-02.20 SPHERES MILK JUG / 0.20L

KUBA



KUBA ALL-IN-ONE TABLE SET A

NEW

FRONT VIEW



REAR VIEW



FEATURING:

- ① CW-103 MILK JUG/ 0.18L
- ② TOP-50 SUGAR SACHET HOLDER/
74×66×52(H)MM
- ③ TOP-49 CHOPSTICKS & CUTLERY HOLDER/
80×80×140(H)MM
- ④ TOP-53 TOOTHPICKS HOLDER/
60×43×62(H)MM
- ⑤ NS-160125.08 SLATE NAPKIN TRAY/
160×125×8(H)MM
- ⑥ TOP-56 WOODEN TRAY/
382×182×24(H)MM
- ⑦ CW-105 SALT SHAKER/
85(H)MM
- ⑧ CW-106 PEPPER SHAKER/
85(H)MM
- ⑨ PU-001 CUTLERY POUCH/ 260MM



KUBA ALL-IN-ONE TABLE SET B

NEW

FRONT VIEW

REAR VIEW



FEATURING:

- ① CW-103 MILK JUG/ 0.18L
- ② TOP-50 SUGAR SACHET HOLDER/
74×66×52(H)MM
- ③ TOP-49 CHOPSTICKS & CUTLERY HOLDER/
80×80×140(H)MM
- ④ TOP-53 TOOTHPICKS HOLDER/
60×43×62(H)MM
- ⑤ NS-160125.08 SLATE NAPKIN TRAY/
160×125×8(H)MM
- ⑥ TOP-56 WOODEN TRAY/
382×182×24(H)MM
- ⑦ SM-41.06-B SALT MILL/
APPROX. 6" (H)
- ⑧ PM-41.06-B PEPPER MILL/
APPROX. 6" (H)
- ⑨ PU-001 CUTLERY POUCH/ 260MM

MESSINA



ASIAN INFLUENCE

BEAUTIFULLY CRAFTED CONDIMENT WARE ADDING APPETITE & TASTE TO THE FUSION TABLE.

MESSINA CHILI PASTE CANISTER ^



GW-211/ 65×63×88(H)MM

MESSINA SOYA SAUCE BOTTLE



GW-210/ 77×63×97(H)MM

MESSINA OIL & VINEGAR BOTTLE



GW-209/ 70×68×137(H)MM

^ SPOON IS NOT INCLUDED



FEATURING:

- ① STR-11 MESSINA CONDIMENT TRAY/ 180×160×20(H)MM
- ② GW-210 MESSINA SOYA SAUCE BOTTLE/ 77×63×97(H)MM
- ③ GW-209 MESSINA OIL & VINEGAR BOTTLE/ 70×68×137(H)MM
- ④ GW-211 MESSINA CHILI PASTE CANISTER/ 65×63×88(H)MM
- ⑤ 706-CS/ COFFEE SPOON/ 113MM



CHEESE CANISTER TOP-35, CONSISTING OF:

- ① CANISTER: Ø86×46(H)MM W/ LID
- ② PLATE: Ø125×10(H)MM (SPOON IS NOT INCLUDED)



KUBA CONDIMENT SET TOP-28, CONSISTING OF:

- ① TOP-28_TRAY STAINLESS STEEL TRAY/ DISCONTINUED M
- ② 4PCS OF 709-CS CONDIMENT SPOON/ DISCONTINUED
- ③ 4PCS OF GW-205 GLASS CANISTER/ DISCONTINUED WITH S/S LID



KUBA MINI CONDIMENT SET TOP-27, CONSISTING OF:

- ① TOP-27_TRAY STAINLESS STEEL TRAY/ DISCONTINUED
- ② 4PCS OF 848-CDS CONDIMENT SPOON/ DISCONTINUED
- ③ 4PCS OF GW-204 GLASS CANISTER/ DISCONTINUED WITH S/S LID

CASSANDRA TOOTHPICKS HOLDER



BQ-201/ Ø34×77(H)MM

CASSANDRA SALT SHAKER



BQ-601/ Ø34×84(H)MM

CASSANDRA PEPPER SHAKER



BQ-602/ Ø34×84(H)MM

CASSANDRA TABLE LAMP



BQ-701A/ **DISCONTINUED**



BQ-701B/ **DISCONTINUED**



BQ-701C/ **DISCONTINUED**



FEATURING:

- ① 848-CBS CHESA CHINESE BANQUET SPOON/ 210MM
- ② BQ-111 CHOPSTICKS REST/ 78×12×15(H)MM
- ③ BQ-001 CHESA CHOPSTICKS, BLACK/ 272MM
- ④ BQ-003 CHESA CHOPSTICKS, IVORY/ 272MM

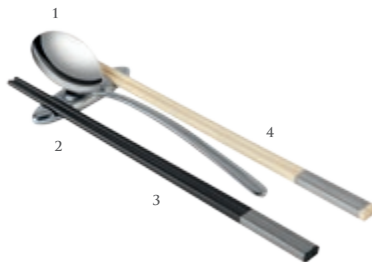

FEATURING:

- ① 801-CBS SONIA CHINESE BANQUET SPOON/ 210MM
- ② BQ-105 CHOPSTICKS REST/ 95×25×12(H)MM
- ③ BQ-001 CHESA CHOPSTICKS, BLACK/ 272MM
- ④ BQ-003 CHESA CHOPSTICKS, IVORY/ 272MM



FEATURING:

- ① 801-CBS SONIA CHINESE BANQUET SPOON/ 210MM
- ② BQ-104 CHOPSTICKS REST/ 75×25×12(H)MM
- ③ BQ-001 CHESA CHOPSTICKS, BLACK/ 272MM



FEATURING:

- ① TOP-11 DOLCE S/S BOWL/ Ø100×40(H)MM
- ② SAU-04.132 S/S SAUCER/ Ø132MM
- ③ BQ-401 TOWEL TRAY/ 150×70×12(H)MM

CASSANDRA MENU STAND



BQ-501.80/ 80(H)MM

CASSANDRA NAPKIN RING



BQ-301/ Ø49×28(H)MM

IMPERIAL BUTTER DISH SET



TOP-02/ Ø78×67(H)MM

IMPERIAL DOME PLATE COVER



TOP-10/ Ø280×165(H)MM



TOP-09/ Ø250×160(H)MM

IMPERIAL SHOW PLATE



SPL-01.31/ Ø310×18(H)MM

CASSANDRA CANDLE STAND



BQ-702.1/ **DISCONTINUED**



BQ-702.3/ **DISCONTINUED**



BQ-702.5/ **DISCONTINUED**

CASSANDRA TABLE NUMBER STAND



BQ-501.305/ 305(H)MM



BQ-501.380/ 380(H)MM



BQ-501.460/ 460(H)MM

BUFFET DISPLAY





CASPER MERCHANT BOX

THE RANGE OFFERS TRAYS & RISERS IN DIFFERENT SIZES.
 BY STACKING UP YOUR DESIRED SIZE AND HEIGHT,
 YOUR UNIQUE COMBINATION IS FORMED.
 HIGHLY FLEXIBLE & ADAPTABLE, MADE WITH NATURAL
 ASH WOOD.

TRAY - UPWARDS



TR-1601-AS/ 180x180x75(H)MM



BREAD BASKET



CONDIMENT TRAY

TRAY - DOWNWARDS



TR-1601-AS/ 180x180x75(H)MM



DISPLAYER FOR BUTTER BOWL

TRAY - UPWARDS



TR-1602-AS/ 425×145×60(H)MM



HONEY & JAM TRAY

TRAY - DOWNWARDS



TR-1602-AS/ 425×145×60(H)MM



DISPLAYER FOR CEREAL BOWLS

RISER WITH NATURAL SLATE ^



- ① NS-400120.08/ 400×120×8(H)MM
- ② TR-1602RI-AS/ 425×145×60(H)MM



DISPLAYER FOR PICKLE BOWLS

STACKING UP TO DESIRED HEIGHT



- ① TR-1602-AS/ 425×145×60(H)MM
- ② TR-1602RI-AS/ 425×145×60(H)MM



DISPLAYER FOR CEREAL BOWLS

STACKING UP TO DESIRED HEIGHT



- ① ② TR-1602RI-AS/ 425×145×60(H)MM
- ③ TR-1602-AS/ 425×145×60(H)MM



DRINKS STATION

TRAY - UPWARDS



TR-1603-AS/ 325×325×60(H)MM



BREAD TRAY

TRAY - DOWNWARDS



TR-1603-AS/ 325×325×60(H)MM



DISPLAYER FOR FRUIT PLATE

RISER WITH NATURAL SLATE ^



- ① NS-300300.08/300×300×8(H)MM
- ② TR-1603RI-AS/325×325×60(H)MM



DISPLAYER FOR CHEESE

STACKING UP TO DESIRED HEIGHT



- ① TR-1603-AS/ 325×325×60(H)MM
- ② TR-1603RI-AS/325×325×60(H)MM



DISPLAYER FOR FRUIT PLATE

STACKING UP TO DESIRED HEIGHT

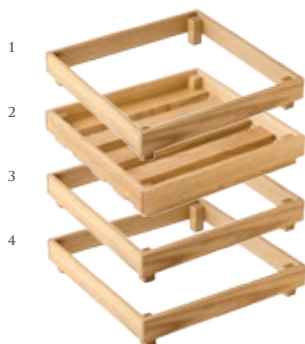

- ① ③ ④ TR-1603RI-AS/ 325×325×60(H)MM
- ② TR-1603-AS/ 325×325×60(H)MM



TROPICAL FRUIT BOX

^ NATURAL SLATE IS A HAND CRAFTED PRODUCT, ABOVE SIZES AND THICKNESSES MAY VARY.

TRAY - UPWARDS



TR-1604-AS/ 525×325×73(H)MM



FRUIT TRAY

TRAY - DOWNWARDS



TR-1604-AS/ 525×325×73(H)MM



DISPLAYER FOR WET MARKET

RISER WITH NATURAL SLATE ^



- ① NS-500300.08/ 500×300×8(H)MM
- ② TR-1604RI-AS/ 525×325×73(H)MM



DISPLAYER FOR COLD CUT

STACKING UP TO DESIRED HEIGHT



- ① TR-1604-AS/ 525×325×73(H)MM
- ② TR-1604RI-AS/ 525×325×73(H)MM



DISPLAYER FOR WET MARKET

STACKING UP TO DESIRED HEIGHT



- ① TR-1604RI-AS/ 525×325×73(H)MM
- ② TR-1604-AS/ 525×325×73(H)MM



BREAD BOX

OLD FARMER

INSPIRED BY FRESH MARKET, OLD FARMER MERCHANT BOX RESEMBLES THE FORM OF FOOD DISPLAY THAT BRINGS THE NATURAL COLORS AND THE ESSENTIAL RUSTIC TOUCH TO THE BUFFET TABLE.



OLD FARMER MERCHANT BOX



RI-16.300200.90/ 300×200×90(H)MM



RI-16.300300.135/ 300×300×135(H)MM



RI-16.400300.150/ 400×300×150(H)MM

NORDICA



NORDICA FRUIT TRAY AND STAND ^



BU-36/ ø250x40(H)MM
RI-12.180R.130/ ø180x130(H)MM



BU-37/ ø305x50(H)MM
RI-12.200R.155/ ø200x155(H)MM



BU-38/ ø345x50(H)MM
RI-12.220R.175/ ø220x175(H)MM



DRAKE

DRAKE 3-TIERS DISPLAYER HAS A COMPACT DESIGN AS A SET OF DRAWERS YET FLEXIBLE TO BE FREE STANDING TO CREATE AN EYE-CATCHING CORNER. PERFECT FOR DISPLAYING BREADS, PASTRY AND FRUITS.

DRAKE 3 TIERS DISPLAYER SET ^



3 TIERS DISPLAYER SET, SMALL/ RI-11.250250.SET3

CONSISTING OF:

- ① RI-11.250250.250/ DISCONTINUED M
- ② RI-11.250220.165/ DISCONTINUED M
- ③ RI-11.250190.80/ DISCONTINUED M



3 TIERS DISPLAYER SET, LARGE/ RI-11.325325.SET3

CONSISTING OF:

- ① RI-11.325325.325/ DISCONTINUED M
- ② RI-11.325285.215/ DISCONTINUED M
- ③ RI-11.325245.105/ DISCONTINUED M

^ MAKE-TO-ORDER ITEM REQUIRING A LONGER PRODUCTION LEADTIME, PLEASE CHECK WITH YOUR LOCAL DISTRIBUTOR FOR MORE INFORMATION.



ASHLEY & ZEN

ASHLEY SERVING BOARD & ZEN RISER

NEW



FEATURING:

- ① TR-2201.2 / SERVING BOARD SET
- SLATE PLATE / Ø250 x 8(H)MM
- WOODEN BOARD / Ø290 x 40(H)MM
- ② RI-10.235235.135 / ZEN RISER
235x235x135(H)MM



FEATURING:

- ① TR-2202.2 / SERVING BOARD SET
- SLATE PLATE / Ø300 x 8(H)MM
- WOODEN BOARD / Ø340 x 40(H)MM
- ② RI-10.280280.270 / ZEN RISER
280x280x270(H)MM



FEATURING:

- ① TR-2203.2 / SERVING BOARD SET
- SLATE PLATE / Ø350 x 8(H)MM
- WOODEN BOARD / Ø390 x 40(H)MM
- ② RI-10.330330.380 / ZEN RISER
330 x 330 x 380(H)MM



ZEN RISER HAS A SLIM AND DAINTY SHAPE WHICH STANDS ALONG WELL WITH MOST KINDS AND SIZES OF PLATES. IT CAN BE STOOD BOTH WAYS TO CREATE THE BEST MATCHING VISUAL WITH THE SHAPE OF PLATE AND FOOD.

ZEN RISER



RI-10.235235.135/
235×235×135(H)MM
REVERSIBLE DESIGN



RI-10.280280.270/
280×280×270(H)MM
REVERSIBLE DESIGN



RI-10.330330.380/
330×330×380(H)MM
REVERSIBLE DESIGN



ZOIE

NUTS AND DRIED FRUIT CAN NOW BE KEPT FRESH AND CRUNCHY BY THE SMARTLY DESIGNED LID. GUEST CAN NOW ENJOY HIS OWN MIXED YOGURT.

ZOIE YOGURT BOTTLE W/ WOODEN LID



GW-311/ Ø70×85(H)MM, CAP 0.13L



GW-310/ Ø90×100(H)MM, CAP 0.21L



ROSANE & ZOIE

JUICE BOTTLE AND PUDDING BOTTLE RESEMBLE THE SIZE AND SHAPE POPULAR IN THE RETAIL MARKET. SMALLER PORTION MEANS LESS WASTAGE AT BUFFET. REUSABLE CAP AVAILABLE FOR ROSANE, WHILE ZOIE JUICE BOTTLE IS FEATURED WITH SWING CAP WASHABLE FOR REUSE.

ROSANE JUICE BOTTLE
W/ REUSABLE CAP



GW-308.18/ 0.18L

ROSANE PUDDING BOTTLE
W/ REUSABLE CAP



GW-309.08/ 0.08L

ZOIE GOURMET BOTTLE
W/ SWING CAP



GW-302.25/ 200(H)MM 0.25L

CORTE

A CLEAN AND NEAT SOLUTION TO DISPLAY SALAD, FRUIT, DRESSING AND SIDE DISH. WHITE PORCELAIN IS ALWAYS THE BEST PLAYGROUND FOR FRESH FOOD.



CORTE UNIVERSAL BOWL



GH-62/
280×280×130(H)MM



GH-61/
240×240×100(H)MM



GH-60/
200×200×90(H)MM



GH-59/
160×160×70(H)MM



GH-63/
110×110×50(H)MM



NATURAL

A RANGE OF WOOD TEXTURED BOWLS MADE OF POLYSTYRENE WHICH IS SCRATCH PROOF, UNBREAKABLE AND CAN BE PLACED ON ICE DIRECTLY FOR A UNIQUE PRESENTATION OF BUFFET SALAD AND FRUIT.

Thousand Island Dressing

NATURAL UNIVERSAL BOWL

NEW



EL-10182/
Ø160×85(H)MM



EL-10183/
Ø200×95(H)MM



EL-10184/
Ø240×105(H)MM



EL-10161/
Ø310×80(H)MM



EL-10252/
Ø400×87(H)MM



EL-10187/
360×240×85(H)MM

HAZELNUT

A RANGE OF LOVELY SHAPED PLATES & BOWLS FOR SALAD AND FRUIT DISPLAY.
DELIGHT YOUR BUFFET WITH TROPICAL COLORS.



HAZELNUT BOWL



HN-07/ 230×175×90(H)MM



HN-08/ 195×152×75(H)MM



HN-91/ 345×130×70(H)MM

HAZELNUT PLATE



HN-26/ 300×230×28(H)MM



HN-68/ 210×160×25(H)MM



HN-52/ 465×160×34(H)MM



LA TAPAS

MINI ROUND DISH



A-925810 / DISCONTINUED

MINI ROUND DISH W/ BASE



A-925806 / DISCONTINUED

MINI POT W/ HANDLE & LID



A-925809 / DISCONTINUED

BOWL W/ HANDLE



A-925801 / DISCONTINUED

ROUND DISH



A-925002 / DISCONTINUED
A-925005 / DISCONTINUED
A-925007 / DISCONTINUED

ROUND DISH W/ HANDLE



A-925104 / DISCONTINUED

BOWL



A-925223 / DISCONTINUED

ROUND POT W/ LID



A-925211 / DISCONTINUED
A-925213 / DISCONTINUED
A-925215 / DISCONTINUED



ART DE GOURMET III

ADG III IS UPGRADED TO ANSWER THE NEEDS OF COLD FOOD DISPLAY. INSIDE THE WOODEN BOX THERE IS A SET OF ICE PACK TO KEEP THE SLATE AT EVEN AND LOW TEMPERATURE FOR BEST SERVING OF HAM, CHEESE, SUSHI, SALAD AND FRUIT. HI-LOW HANDY DESIGN ENABLES UNLIMITED COMBINATION AND FORMS OF DISPLAY - MOBILE AND VOLATILE.

ART DE GOURMET III COLD DISPLAY SET



- ① NS-180180.08 NATURAL SLATE/ 180×180×8(H)MM
- ② ICG-01 ICE GEL BOX/ 150×150×30(H)MM
- ③ IDT-01.180180.50 DRIP TRAY/ 180×180×50(H)MM
- ④ TR-19.200200.78 WOODEN BOX/ 200×200×78(H)MM
- ⑤ RI-01.200200.60-CHO S/S RISER, CHOCO COLOUR/ 200×200×60(H)MM
- ⑥ RI-01.200200.128-CHO S/S RISER, CHOCO COLOUR/ 200×200×128(H)MM
- ⑦ RI-01.200200.196-CHO S/S RISER, CHOCO COLOUR/ 200×200×196(H)MM
- ⑧ RI-01.200200.264-CHO S/S RISER, CHOCO COLOUR/ 200×200×264(H)MM



ART DE GOURMET III COLD DISPLAY SET



- ① NS-280280.08 NATURAL SLATE/ 280×280×8(H)MM
- ② ICG-02 ICE GEL BOX/ 250×125×30(H)MM
- ③ IDT-01.280280.50 DRIP TRAY/ 280×280×50(H)MM
- ④ TR-19.300300.78 WOODEN BOX/ 300×300×78(H)MM
- ⑤ RI-01.300300.60-CHO S/S RISER,
CHOCO COLOUR/ 300×300×60(H)MM
- ⑥ RI-01.300300.128-CHO S/S RISER,
CHOCO COLOUR/ 300×300×128(H)MM
- ⑦ RI-01.300300.196-CHO S/S RISER,
CHOCO COLOUR/ 300×300×196(H)MM
- ⑧ RI-01.300300.264-CHO S/S RISER,
CHOCO COLOUR/ 300×300×264(H)MM



ART DE GOURMET III

ADG III IS ALSO GOOD FOR DISPLAY OF PASTRY.
NATURAL WARM COLOR OF ACACIA ALWAYS REMINDS
YOU THE UNFORGETTABLE AROMA OF HOMEMADE BREAD AND BUNS.
HI-LOW HANDY DESIGN ENABLES UNLIMITED COMBINATION AND FORMS OF
DISPLAY - MOBILE AND VOLATILE.



ART DE GOURMET III DISPLAY SET



- ① TR-19.200200.78 WOODEN BOX/ 200×200×78(H)MM
- ② RI-01.200200.60-CHO S/S RISER,
CHOCO COLOUR/ 200×200×60(H)MM
- ③ RI-01.200200.128-CHO S/S RISER,
CHOCO COLOUR/ 200×200×128(H)MM
- ④ RI-01.200200.196-CHO S/S RISER,
CHOCO COLOUR/ 200×200×196(H)MM
- ⑤ RI-01.200200.264-CHO S/S RISER,
CHOCO COLOUR/ 200×200×264(H)MM

ART DE GOURMET III DISPLAY SET



- ① TR-19.300300.78 WOODEN BOX/ 300×300×78(H)MM
- ② RI-01.300300.60-CHO S/S RISER,
CHOCO COLOUR/ 300×300×60(H)MM
- ③ RI-01.300300.128-CHO S/S RISER,
CHOCO COLOUR/ 300×300×128(H)MM
- ④ RI-01.300300.196-CHO S/S RISER,
CHOCO COLOUR/ 300×300×196(H)MM
- ⑤ RI-01.300300.264-CHO S/S RISER,
CHOCO COLOUR/ 300×300×264(H)MM

OLD FARMER



OLD FARMER COLD DISPLAY BOX / CDB-811.SET, CONSISTING OF:



WOODEN BOX /
550 X 355 X 150(H)MM



S/S DRIP TRAY



S/S ICE PAN / GN 1/1



NATURAL SLATE PLATE/
530x330x8(H)MM



THE BOX CONTAINS HIDDEN ICE PAN AND DRIP PAN WHICH KEEP THE SLATE COOL THROUGHOUT THE EVENT. PERFECT TO SERVE COLD FOOD ON SLATE OR SEAFOOD AND BOTTLES ON ICE. STURDY BOX DESIGN WITH HANDLES FOR EASY CARRYING AIMED FOR OUTSIDE AND MOBILE CATERING.

OLD FARMER COLD DISPLAY BOX / CDB-812.SET, CONSISTING OF:



WOODEN BOX /
350 X 285 X 150(H)MM



S/S DRIP TRAY



S/S ICE PAN / GN 1/2



NATURAL SLATE PLATE /
325 X 265 X 8(H)MM

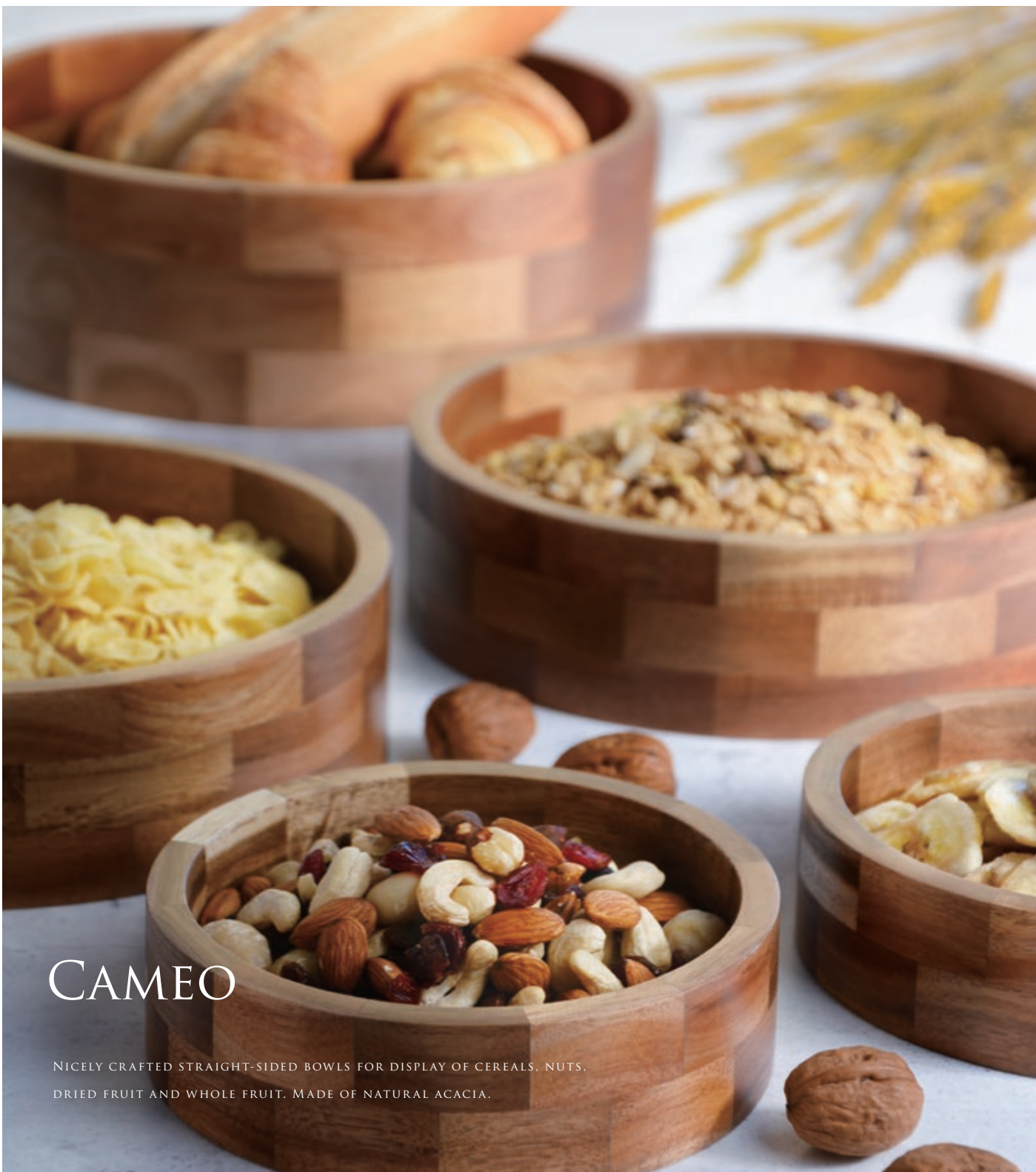

CAMEO

NICELY CRAFTED STRAIGHT-SIDED BOWLS FOR DISPLAY OF CEREALS, NUTS, DRIED FRUIT AND WHOLE FRUIT. MADE OF NATURAL ACACIA.

CAMEO WOODEN BOWL



BU-51/ DISCONTINUED



BU-52/ DISCONTINUED



BU-53/ DISCONTINUED

CASA

SHAPED BEAUTIFULLY, CASA WOODEN BOWLS WILL DEFINITELY ADD ATTRACTION TO YOUR CEREALS AND FRUITS DISPLAY. THREE SIZES AVAILABLE FOR FLEXIBLE COMBINATION OF SERVING.



CASA WOODEN BOWL



BU-33/ 200×185×130(H)MM



BU-34/ 280×265×180(H)MM



BU-35/ 360×340×225(H)MM

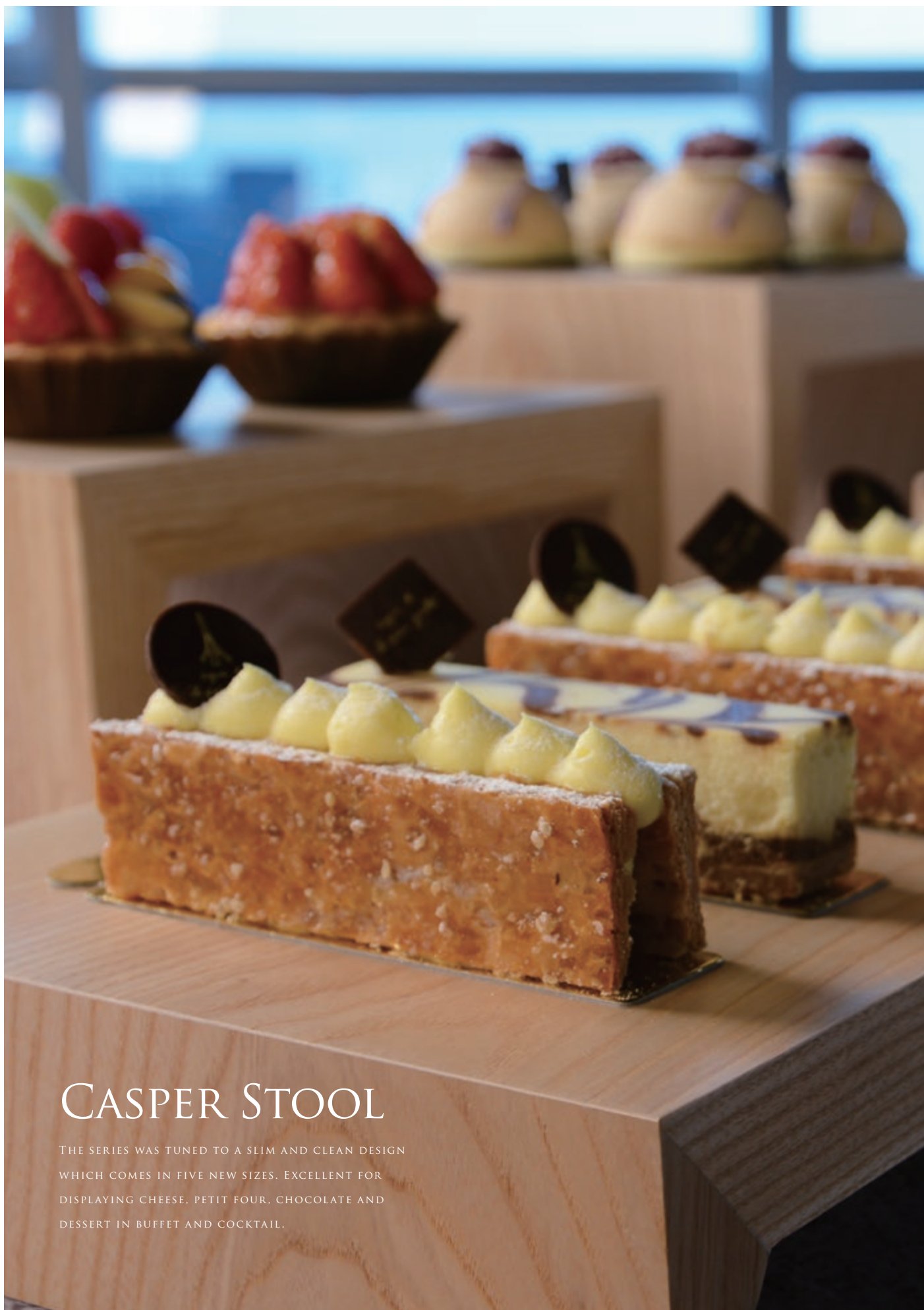

CASPER STOOL

THE SERIES WAS TUNED TO A SLIM AND CLEAN DESIGN WHICH COMES IN FIVE NEW SIZES. EXCELLENT FOR DISPLAYING CHEESE, PETIT FOUR, CHOCOLATE AND DESSERT IN BUFFET AND COCKTAIL.



CASPER WOODEN STOOL



RI-14.200200.90/ 200×200×90(H)MM



RI-14.200200.150/ 200×200×150(H)MM



RI-14.250250.60/ 250×250×60(H)MM



RI-14.250250.120/ 250×250×120(H)MM



RI-14.400200.60/ 400×200×60(H)MM

CASPER BOARD



CB-64-AS/ 400×200×24(H)MM



CB-78-AS/ ø254×24(H)MM



CB-65-AS/ 500×200×24(H)MM



CB-66-AS/ 700×200×24(H)MM



CB-59/ 530×370×40(H)MM

CAMEO

ACACIA TRAYS IN WARM COLOR WITH CLOCHES TO PRESENT AROMATIC MACARON, SWEET AND PETIT FOUR.



CAMEO ROUND TRAY W/ LID



FEATURING:

- ❶ TR-20.182R ROUND TRAY / Ø182X22(H)MM
- ❷ VD-65294 GLASS DOME COVER / Ø160x140(H)MM



FEATURING:

- ❶ TR-20.252R ROUND TRAY / Ø252X30(H)MM
- ❷ VD-65295 GLASS DOME COVER / Ø230x165(H)MM



FEATURING:

- ❶ TR-20.300R ROUND TRAY / Ø300 X 40(H)MM
- ❷ VD-65296 GLASS DOME COVER / Ø275x205(H)MM



CASSANDRA

CASSANDRA TURNED THE COMMON FORM OF CAKE PLATE INTO A BUNCH OF LOVELY WOODEN MUSHROOMS STANDING HIGH AND LOW FOR CAKES, SWEETS, CHOCOLATES AND MACARONS. MATCHING GLASS DOMES AVAILABLE.

CASSANDRA CAKE STAND



FEATURING:

- ① RI-15.180R.100 CAKE STAND/
Ø180×100(H)MM
- ② VD-65294 GLASS DOME COVER/
Ø160×140(H)MM



FEATURING:

- ① RI-15.250R.150 CAKE STAND/
Ø250×150(H)MM
- ② VD-65295 GLASS DOME COVER/
Ø230×165(H)MM



FEATURING:

- ① RI-15.295R.200 CAKE STAND/
Ø295×200(H)MM
- ② VD-65296 GLASS DOME COVER/
Ø275×205(H)MM

ART DE GOURMET I

THE ORIGINAL AND AUTHENTIC SYSTEM FOR FOOD DISPLAY & BUFFET SETTING. IT COMES IN A RANGE OF FOOD SAFE-LAMINATED NATURAL SLATE IN DIFFERENT SIZES PERFECT FOR PETIT FOUR, TASTING MENU, SNACKS & SUSHI...

THE RANGE ALSO GOES ALONG WITH MATCHING RISER STANDS IN HEAVY GAUGE STAINLESS STEEL TO CREATE A STRAIGHT FORWARD BUT NOT OVERWHELMING AID FOR FOOD ART PRESENTATION.



NATURAL SLATE PLATE ^



NS-200100.08/ 200x100x8MM



NS-300120.08/ 300x120x8MM



NS-400120.08/ 400x120x8MM



NS-250R.08/ Ø250x8MM



NS-300R.08/ Ø300x8MM



NS-350R.08/ Ø350x8MM



NS-180180.08/ 180x180x8MM



NS-300300.08/ 300x300x8MM



NS-300200.08/ 300x200x8MM



NS-400250.08/ 400x250x8MM



NS-500300.08/ 500x300x8MM

^ NATURAL SLATE IS A HAND CRAFTED PRODUCT, ABOVE SIZES AND THICKNESSES MAY VARY

STAINLESS STEEL RISER STAND



RI-01.180180.30/
DISCONTINUED



RI-01.180180.120/
180x180x120(H)MM



RI-01.180180.180/
180x180x180(H)MM



RI-01.180180.240/
180x180x240(H)MM



RI-01.120120.30/
DISCONTINUED



RI-01.120120.80/
DISCONTINUED



RI-01.120120.120/
120x120x120(H)MM



RI-01.120120.160/
120x120x160(H)MM



RI-01.120120.240/
120x120x240(H)MM

ART DE GOURMET I

COMBINED DISPLAY SET



PYRAMID IV/ ADG-SET A, CONSISTING OF: NATURAL SLATE ^

- ① NS-300120.08 / 300×120×8MM
- ② NS-200200.08 / 200×200×8MM
- ③ NS-300300.08 / 300×300×8MM
- ④ NS-500300.08 / 500×300×8MM

STAINLESS STEEL RISER STAND

- ⑤ RI-01.120120.30 / 120×120×30(H)MM
- ⑥ 2PCS OF RI-01.120120.80 / 120×120×80(H)MM
- ⑦ 2PCS OF RI-01.180180.30 / 180×180×30(H)MM
- ⑧ RI-01.180180.180 / 180×180×180(H)MM

STEPS III/ ADG-SET B, CONSISTING OF: NATURAL SLATE ^

- ① 3PCS OF NS-400120.08 / 400×120×8MM

STAINLESS STEEL RISER STAND

- ② 2PCS OF RI-01.120120.30 / 120×120×30(H)MM
- ③ 2PCS OF RI-01.120120.120 / 120×120×120(H)MM
- ④ 2PCS OF RI-01.120120.240 / 120×120×240(H)MM



EXECUTIVE VI/ ADG-SET C, CONSISTING OF: NATURAL SLATE ^

- ① 2PCS OF NS-400120.08 / 400×120×8MM
- ② NS-400250.08 / 400×250×8MM
- ③ NS-500300.08 / 500×300×8MM
- ④ NS-300R.08 / Ø300×8MM
- ⑤ NS-350R.08 / Ø350×8MM

STAINLESS STEEL RISER STAND

- ⑥ 2PCS OF RI-01.120120.30 / 120×120×30(H)MM
- ⑦ 2PCS OF RI-01.120120.120 / 120×120×120(H)MM
- ⑧ 2PCS OF RI-01.120120.240 / 120×120×240(H)MM
- ⑨ 3PCS OF RI-01.180180.30 / 180×180×30(H)MM
- ⑩ RI-01.180180.180 / 180×180×180(H)MM



DIAMOND VI/ ADG-SET D, CONSISTING OF:
NATURAL SLATE ^

- ❶ 3PCS OF NS-200200.08 / 200×200×8MM
- ❷ 3PCS OF NS-300300.08 / 300×300×8MM

STAINLESS STEEL RISER STAND

- ❸ 3PCS OF RI-01.120120.30 / 120×120×30(H)MM
- ❹ 3PCS OF RI-01.180180.120 / 180×180×120(H)MM

CRESENT V/ ADG-SET F, CONSISTING OF:
NATURAL SLATE ^

- ❶ 5PCS OF NS-300R.08 / Ø300×8MM

STAINLESS STEEL RISER STAND

- ❷ 2PCS OF RI-01.180180.30 / 180×180×30(H)MM
- ❸ 2PCS OF RI-01.180180.120 / 180×180×120(H)MM
- ❹ RI-01.180180.180 / 180×180×180(H)MM



CRESENT VII/ ADG-SET G, CONSISTING OF:
NATURAL SLATE ^

- ❶ 3PCS OF NS-300R.08 / Ø300×8MM
- ❷ 4PCS OF NS-350R.08 / Ø350×8MM

STAINLESS STEEL RISER STAND

- ❸ 2PCS OF RI-01.180180.30 / 180×180×30(H)MM
- ❹ 2PCS OF RI-01.180180.120 / 180×180×120(H)MM
- ❺ 2PCS OF RI-01.180180.180 / 180×180×180(H)MM
- ❻ RI-01.120120.240 / 120×120×240(H)MM

^ NATURAL SLATE IS A HAND CRAFTED PRODUCT, ABOVE SIZE AND THICKNESS MAY VARY

CASPER

CASPER RANGE DESIGNER SHELF OFFERS A 2-TIERS AND A 5-TIERS VERSION PERFECT FOR DISPLAYING BREADS, FRUITS, MAGAZINES, GUEST AMENITIES AND MANY MORE. IT CAN BE APPLIED TO BUFFET, ALL DAY DINNING, GUEST CORNER OR RESTING AREA. EACH SHELF BOARD CAN BE ADJUSTED TO STAY HORIZONTALLY OR SLANTED DEPENDING ON YOUR NEED. NATURAL ASH CONSTRUCTION, STURDY AND DURABLE.



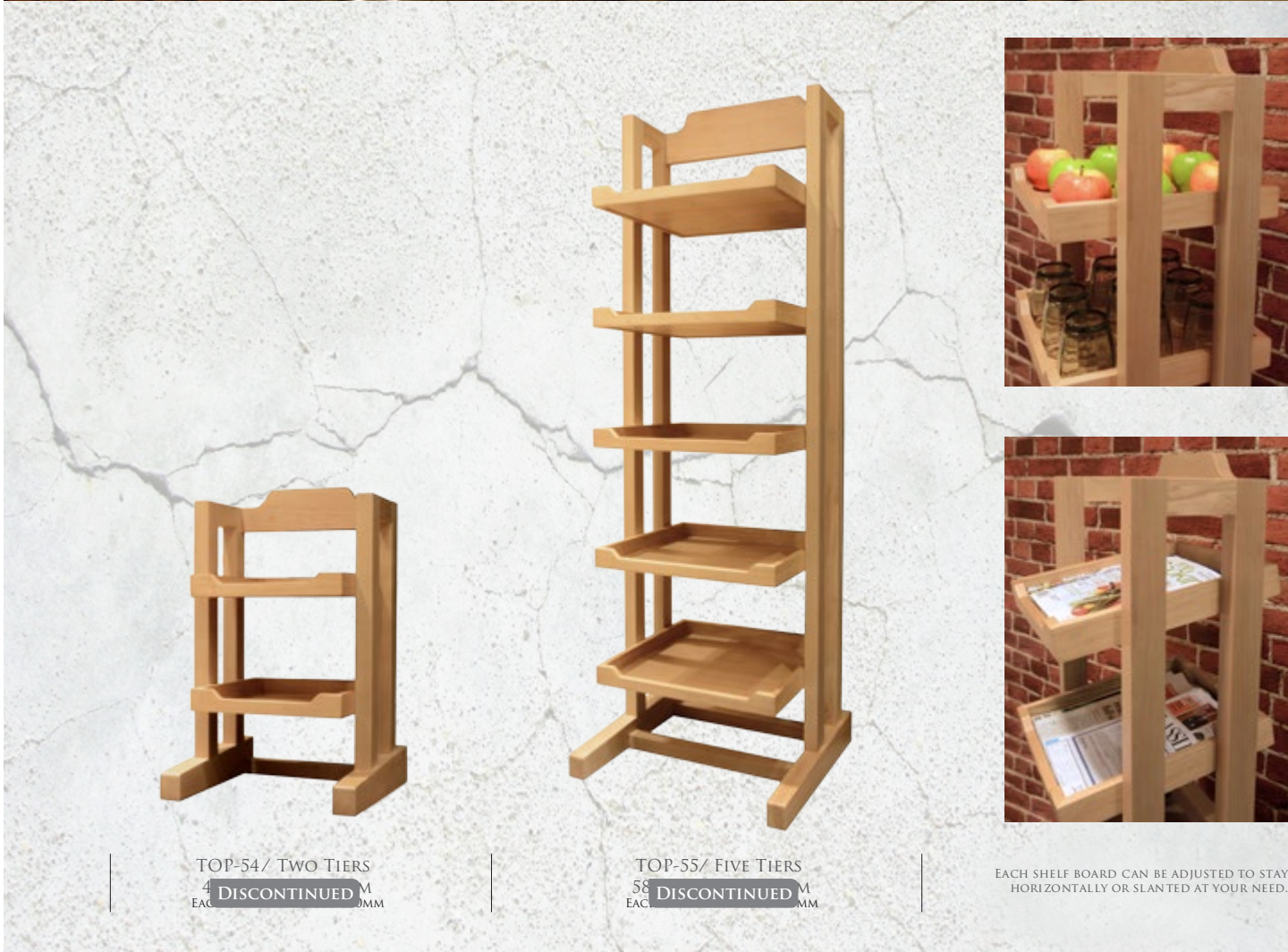

TOP-54/ TWO TIERS
4 DISCONTINUED M
EAC 58

TOP-55/ FIVE TIERS
58 DISCONTINUED M
EAC 58

EACH SHELF BOARD CAN BE ADJUSTED TO STAY HORIZONTAL OR SLANTED AT YOUR NEED.



REECE MINI TUREEN & STAND

REECE MINI TUREEN STAND

REECE MINI TUREEN/ Ø100×85(H)MM 0.20L



1

2

FEATURING:

- ① RI-13.486180.145 WOODEN STAND/ 486×180×145(H)MM
- ② RI-13.486180.58 WOODEN STAND/ 486×180×58(H)MM



CW-501-CHO/ CHOCOLATE



CW-501-COB/ **DISCONTINUED**



CW-501-YEL/ YELLOW



CW-501-RED/ RED

BUFFET ESSENTIALS

THE NECESSARY SUPPLEMENTS TO COMPLETE THE PERFECT BUFFET SETTING

BUFFET TAG HOLDER



BU-44/
50x15x15(H)MM



BU-29-WN/
50x15x15(H)MM



BU-45/
20x20x18(H)MM



BU-42/
20x20x18(H)MM



BU-43/
50x18x14(H)MM

NATURAL STONE BUFFET TAG HOLDER ^



BU-55-LG/ LIGHT GREY
APPROX. 75x45x35(H)MM^



BU-55-DG/ DARK GREY
APPROX. 75x45x35(H)MM^

UNIVERSAL BOWL



GH-55/ WHITE
DISCONTINUED



GH-55-BLK/ BLACK
DISCONTINUED

CASSANDRA UNIVERSAL BOWL



BU-25/ Ø140x70(H)MM



BU-26/ Ø220x103(H)MM



BU-27/ Ø360x180(H)MM

CASSANDRA DELUXE PUNCH BOWL



BW-19/ Ø440x305(H)MM

IMPERIAL BANQUET PLATE



SPL-01.40/ Ø400x21(H)MM



SPL-01.52/ Ø520x23(H)MM

APPLE TREE



GH-18/ DISCONTINUED

APPLE TREE, MINI



GH-35/ DISCONTINUED

CROWN BREAD / FRUIT BASKET



GH-05/ DISCONTINUED



FEATURING:

- 1 BU-22 DORF DESSERT STAND/ DISCONTINUED
445x68x55(H)MM
- 2 6PCS OF GSG-03.10 DESSERT GLASS/ DISCONTINUED

^NATURAL HANDCRAFTED, SLIGHT VARIATION IN COLOR, SIZE & SHAPE IN EACH PIECE

BUFFET ESSENTIALS



CHEESE BOARD (KNIFE NOT INCLUDED)
CB-59-A/ 530X370X40(H)MM



NEW

BREAD BOARD (KNIFE NOT INCLUDED)
CB-96/ 440x280x40(H)MM



GRANDE PLUS CHEESE KNIFE
GP-C01/ DISCONTINUED



GRANDE PLUS CHEESE KNIFE
GP-C02/ DISCONTINUED



GRANDE PLUS CHEESE KNIFE
GP-C03/ DISCONTINUED



GRANDE PLUS CHEESE KNIFE
GP-C04/ DISCONTINUED



GRANDE PLUS CHEESE KNIFE
GP-C05/ 170MM BLADE



FORI CHEESE KNIFE
F-51/ 170MM BLADE



GRANDE PLUS BREAD KNIFE
GP-52/ BLADE: 240MM
OVERALL: 370MM

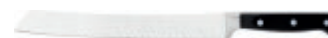

FORI BREAD KNIFE
F-52/ BLADE: 255MM
OVERALL: 385MM



CARVING KNIFE
F-60/ 385MM
BLADE: 255MM



CARVING FORK
F-15/ 280MM

BUFFET MINIWARE



KUBA SQUARE BOWL/ 60×60×52(H)MM



CW-001/ WHITE



CW-001-EGP/ EGGPLANT



CW-001-OLI/ **DISCONTINUED**



CW-001-WGR/ **DISCONTINUED**

KUBA SQUARE PLATE/ 60×60×25(H)MM



CW-601/ WHITE



CW-601-EGP/ **DISCONTINUED**



CW-601-OLI/ OLIVE



CW-601-WGR/ **DISCONTINUED**

KUBA SQUARE PLATE/ 80×80×20(H)MM



CW-201/ WHITE



CW-201-EGP/ **DISCONTINUED**



CW-201-OLI/ **DISCONTINUED**



CW-201-WGR/ WARM GREY

HAZELNUT MINI PLATE
NEW



HN-413/ 120×85×28(H)MM
HN-415/ 103×68×30(H)MM

NEW



HN-71/ 100×80×20(H)MM

HAZELNUT MINI BOWL
NEW



HN-09/ 100×85×62(H)MM

CORTE GOURMET BOWL
NEW



CW-005/ 95×70×35(H)MM
CW-006/ 110×95×48(H)MM

DAPHNE GOURMET GLASS



GW-602.04/ **DISCONTINUED**



GW-602.08/ **DISCONTINUED**



GW-602.12/ **DISCONTINUED**

DAPHNE GOURMET BOWL



GW-102/ Ø86×46(H)MM

ZOIE GOURMET GLASS



GW-601.06/ **DISCONTINUED**



GW-603.12/ **DISCONTINUED**

DORF GOURMET GLASS



GSG-03.10/ 0.10L

LEXI GOURMET GLASS



GSG-01.10/ 0.10L

ZOIE GOURMET JAR



GW-303.06/ **DISCONTINUED**
MATCH WITH 848-CS



GW-304.08/ **DISCONTINUED**
MATCH WITH 848-CS



GW-305.10/ **DISCONTINUED**
MATCH WITH 848-CS

KUBA GOURMET GLASS



GW-204/ 40×40×40(H)MM
GW-205/ 60×60×52(H)MM

FORT ENAMEL CAST IRON

ATHENA IS PROUD TO LAUNCH HER FIRST RANGE OF ENAMEL CAST IRON PANS AND POTS – FORT – WHICH ANSWERED TO THE NEEDS OF COLOURS AND PERFORMANCE REQUIRED BY THE BUFFET TABLES AND KITCHENS. EIGHT IRRESISTIBLE COLOURS IN NINE FUNCTIONAL SHAPES ARE AVAILABLE AT YOUR CHOICE.







FORT

ATHENA ENAMEL CAST IRON PANS AND POTS BRING STYLE AND COLORS TO BUFFET. THEY ARE EXCELLENT FOR HOT FOOD DISPLAY. THEY WORK ON INDUCTION, HOT PLATE AND GAS STATION AT A LOW ENERGY CONSUMPTION LEVEL AND KEEP FOOD HOT AND FRESH.

ROUND MINI POT



CI-10RP6/ **DISCONTINUED** 3L

SAUCE PAN



CI-16SP10/ **DISCONTINUED** 3L

RECTANGULAR ROASTING DISH



CI-30TD22/ **DISCONTINUED** 2.6L

GRILL PAN



CI-28GP28/ **DISCONTINUED** 1.8L

WOK



CI-28WK8/ **DISCONTINUED** .8L



CI-36WK10/ **DISCONTINUED** 2.2L

COLOUR CHOICES:

RED=RED 

ORANGE=ORA 

CYAN=CYN 

ASH=ASH 



ROUND POT

FRYPAN DOUBLE HANDLE



CI-24RP12/ **DISCONTINUED** 3.8L



CI-30DFP7/ **DISCONTINUED** 3L



CI-30VP15/ **DISCONTINUED** 5.3L

LID STAND

REECE WOODEN STAND FOR MINI POTS



BU-41/ 160x153x198(H)MM



RI-13.486180.58/ 486x180x58(H)MM



RI-13.486180.145/ 486x180x145(H)MM

BLACK=BLK 

COBALT=CBT 

CREAM=CRM 

YELLOW=YEL 

FORT

TO DISPLAY RICE AND PASTA FRESH AND MOIST, ATHENA OFFERS NEW PORCELAIN STEAM PAN FITTING PERFECTLY TO HER CAST IRON ENAMEL POTS – AVAILABLE IN ROUND & OVAL. FILL HOT WATER IN POT, APPLY TO INDUCTION OR WARMER AT LOW TO MEDIUM HEAT LEVEL, THE STEAM INSIDE THE POT WILL WARM THE FOOD INDIRECTLY AND THIS KEEPS RICE AND PASTA HOT AND FRESH.





NEW



FEATURING:

- ❶ CI-24RP12 FORT ROUND POT/ DISCONTINUED
Ø240×120(H)MM 3.8L
- ❷ FP-2000 ROUND FOOD PAN/ DISCONTINUED
Ø244×89(H)MM 2.0L

NEW



FEATURING:

- ❶ CI-30VP15 FORT OVAL POT/ DISCONTINUED
300×220×143(H)MM 5.3L
- ❷ FP-3000V OVAL FOOD PAN/ DISCONTINUED
304×224×112(H)MM 3.0L

FORT

ATHENA IS PROUD TO OFFER A NICE DIM-SUM PRESENTATION BY APPLYING THE NEW STAINLESS STEEL STEAMER ONTO HER CAST IRON ENAMEL WOK IN TWO SIZES. IT IS STURDY AND HYGIENIC, STACKABLE AND FUNCTIONAL. AVAILABLE IN TWO SIZES WITH TEMPERED GLASS LID.





NEW



FEATURING:

- ① CI-28WK8 FORT WOK/ DISCONTINUED 1.8L
- ② AP-05 ADAPTING PLATE/ DISCONTINUED
- ③ ST-205 STEAMER/ DISCONTINUED
- ④ ST-205 _ LID GLASS LID/ DISCONTINUED

NEW



FEATURING:

- ① CI-36WK10 FORT WOK/ DISCONTINUED 2.2L
- ② AP-06 ADAPTING PLATE/ DISCONTINUED
- ③ ST-252 STEAMER/ DISCONTINUED
- ④ ST-252 _ LID GLASS LID/ DISCONTINUED



FORT

TO SERVE CRISPY SNACKS, ATHENA OFFERS NEW MESH GRIDS WHICH FIT INTO HER CAST IRON ENAMEL GRILL PAN, ROASTING PAN AND FRYPAN RESPECTIVELY. APPLY THE CAST IRON ON INDUCTION OR WARMER AT A LOW HEAT LEVEL, THE WARM AIR WILL KEEP THE SNACKS FRESH AND CRISPY. AVAILABLE IN THREE SIZES.



NEW



FEATURING:

- ① CI-30TD22 FORT ROASTING DISH/ DISCONTINUED
300×200×55(H)MM 2.6L
- ② FR-30TD22-ZR FOOD RACK/ DISCONTINUED
274×194×20(H)MM

NEW



FEATURING:

- ① CI-28GP28 FORT GRILL PAN/ DISCONTINUED
280×280×50(H)MM 1.8L
- ② FR-28GP28-ZR FOOD RACK/ DISCONTINUED
235×235×20(H)MM

NEW



FEATURING:

- ① CI-30DFP7 FORT FRYPAN/ DISCONTINUED
Ø300×70(H)MM 3.3L
- ② FR-30DFP7-ZR FOOD RACK/ DISCONTINUED
Ø260×20(H)MM



DELI PAN W/ DOUBLE HANDLES

LE FON FRY PAN



DE-12520-DGH/ Ø125×20(H)MM
 DE-16026-DGH/ Ø160×26(H)MM
 DE-20035-DGH/ Ø200×35(H)MM
 DE-24040-DGH/ Ø240×40(H)MM



DE-28045-DGH/ Ø280×45(H)MM
 DE-31550-DGH/ Ø315×50(H)MM
 DE-36055-DGH/ Ø360×55(H)MM



LF-10525-BH/ Ø105×25(H)MM
 LF-20538-BH/ Ø205×38(H)MM
 LF-25045-BH/ Ø250×45(H)MM

LE FON & DELI

HAMMERED FRENCH STYLE PANS AND POTS IN DIFFERENT SIZES SERVING THE HOT AND GRILL, SIDE DISH AND CONDIMENT, ADDING A RUSTIC TOUCH TO BUFFET.



LE FON SAUCE PAN



LF-10045-BH/ Ø100×45(H)MM
LF-165105-BH/ Ø165×105(H)MM

LE FON ROUND POT



LF-8570-DBH/ Ø85×70(H)MM
LF-12585-DBH/ Ø125×85(H)MM



LF-25585-DBH/ Ø255×85(H)MM
LF-285100-DBH/ Ø285×100(H)MM
LF-325120-DBH/ Ø325×120(H)MM



REGAL



DELUXE INDUCTION CHAFING DISH

REGAL IS THE FACE-LIFTED VERSION OF PRINCE WHICH FEATURES A BIG TEMPERED GLASS LID PROVIDING A PANORAMIC VIEW OF FOOD AIMING TO RAISE APPETITE. IT HAS A CLEAN AND SLIM SILHOUETTE AND TOP QUALITY DEFINED BY THE PATENTED HYDRAULIC HINGE AND HEAVY GAUGE STAINLESS STEEL BODY.

SMOOTH OPENING, AUTO STOP, SILENT CLOSING. GOOD FOR INDUCTION, ELECTRIC AND FUEL.

- 18/10 STAINLESS STEEL BODY
- WITH CAPSULED BOTTOM COMPATIBLE FOR INDUCTION, CHAFER FUEL AND ELECTRIC HEATER
- EU1935/2004 FOOD SAFE STANDARD CONFORMED

DETACHABLE LID
– FOR QUICK & EASY CLEANING

LID POSITION
– OPENS UP TO MAXIMUM 90°
– STAYS OPEN AT APPROX. 75°
– INITIATE TO CLOSE BY PRESSING DOWN GENTLY
– LID FALLS & CLOSSES AUTOMATICALLY & SILENTLY

NOISE STOPPER
– EASES NOISE OF CLOSING LID

WATER RETURN SYSTEM
– CONDENSATION FLOWS BACK TO WATER PAN INSTEAD OF FOOD

CONVENIENT NOTCH
– CHANGING FOOD PAN EASILY

CAPSULED BOTTOM
– MULTI-LAYER BOTTOM FOR FAST & EVEN HEATING

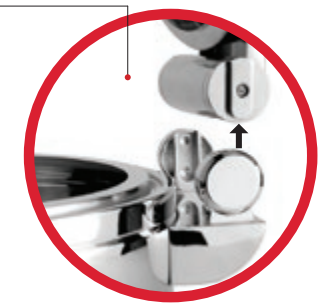

HYDRAULIC HINGE
– FOR SMOOTH OPENING & CLOSING OF LID



REGAL ROUND

ROUND CHAFING DISH
OPTIONAL 36CM FOOD PAN 6.1 LTR.

w/ GLASS LID 



A-4560 L

DIMENSIONS

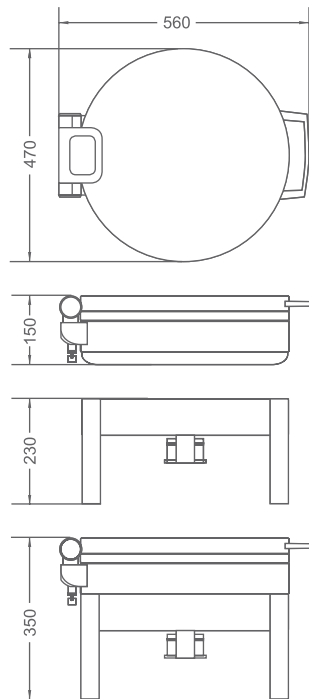

A-4560 L WITH STAND



STACKABLE DESIGN

- MATCHING STAND A-2060F

OPTIONAL ACCESSORIES:

CHROME-NICKEL STAINLESS STEEL
EU 1935/2004 FOOD SAFE
STANDARD CONFORMED



RF 36-2
36CM ROUND FOOD PAN 6.1 LTR.



RF 36/ 2-2
DIVIDED 36CM ROUND FOOD PAN 5.8 LTR.

VITRIFIED NON-POROUS
PORCELAIN FOOD PAN
EU 1935/2004 FOOD SAFE
STANDARD CONFORMED



PRF 36-2
36CM ROUND FOOD PAN 6.1 LTR.



PRF 36/ 2-2
DIVIDED 36CM ROUND FOOD PAN 5.8 LTR.

CHOICE OF HEATING

ELEMENTS :



EXTERNAL INDUCTION
DEVICE



FUEL



INDUCTION UNIT
GO WITH STAND



EXTERNAL ELECTRICAL
DEVICE

REGAL

ROUND - SMALL

ROUND CHAFING DISH
OPTIONAL 28CM FOOD PAN 4.0 LTR.

W/ GLASS LID 



A-4540 L

DIMENSIONS

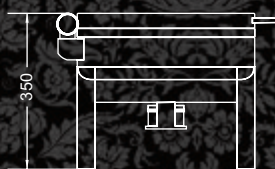
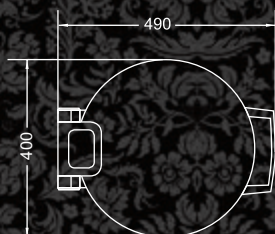

A-4540 L WITH STAND



STACKABLE DESIGN

- MATCHING STAND A-2040F

OPTIONAL ACCESSORIES:

CHROME-NICKEL STAINLESS STEEL
EU 1935/2004 FOOD SAFE
STANDARD CONFORMED



RF 28-2
28CM ROUND FOOD PAN 4.0 LTR.

VITRIFIED NON-POROUS
PORCELAIN FOOD PAN
EU 1935/2004 FOOD SAFE
STANDARD CONFORMED



PRF 28-2
28CM ROUND FOOD PAN 4.0 LTR.



PRF 28-2/2
DIVIDED 28CM ROUND FOOD PAN 2.5 LTR.

CHOICE OF HEATING

ELEMENTS :



REGAL SOUP STATION

SOUP STATION
W/ 11 LTR. SOUP BUCKET

W/ GLASS LID 



A-45-11 L

DIMENSIONS

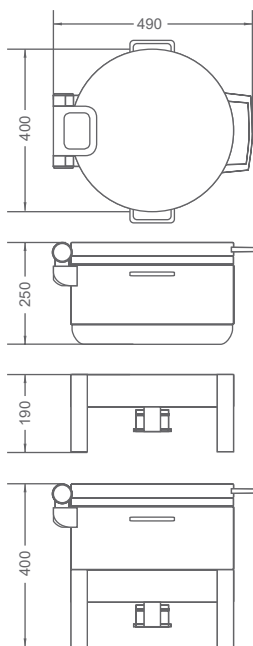

A-45-11 L WITH STAND



- MATCHING STAND A-20-11F



CHOICE OF HEATING ELEMENTS :

 EXTERNAL INDUCTION
DEVICE

 FUEL

 INDUCTION UNIT
GO WITH STAND

 EXTERNAL ELECTRICAL
DEVICE

REGAL

GN 1 /1

OBLONG CHAFING DISH

OPTIONAL GN 1/1 FOOD PAN 9.0 LTR.

W/ GLASS LID 



A-4511 L

DIMENSION

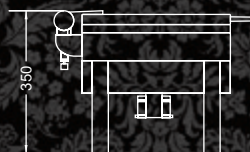
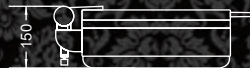
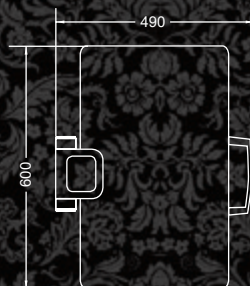

A-4511 L WITH STAND



STACKABLE DESIGN

- MATCHING STAND A-2011F

OPTIONAL ACCESSORIES:

CHROME-NICKEL STAINLESS STEEL
EU 1935/2004 FOOD SAFE
STANDARD CONFORMED



811-2
GN 1/1 FOOD PAN 9.0 LTR.



812-2
GN 1/2 FOOD PAN 4.3 LTR.

VITRIFIED NON-POROUS
PORCELAIN FOOD PAN
EU 1935/2004 FOOD SAFE
STANDARD CONFORMED



P 811-2
GN 1/1 FOOD PAN 9.0 LTR.



P 812-2
GN 1/2 FOOD PAN 4.3 LTR.

CHOICE OF HEATING

ELEMENTS :



EXTERNAL INDUCTION
DEVICE



FUEL



INDUCTION UNIT
GO WITH STAND



EXTERNAL ELECTRICAL
DEVICE

REGAL

GN 2/3

OBLONG CHAFING DISH

OPTIONAL GN 2/3 FOOD PAN 5.9 LTR.

w/ GLASS LID 



A-4532 L

DIMENSIONS

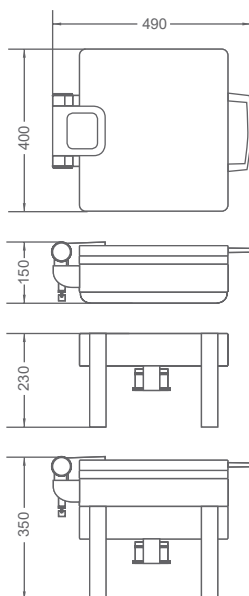

A-4532 L WITH STAND



STACKABLE DESIGN

- MATCHING STAND A-2032F

OPTIONAL ACCESSORIES:

CHROME-NICKEL STAINLESS STEEL
EU 1935/2004 FOOD SAFE
STANDARD CONFORMED



823-2
GN 2/3 FOOD PAN 5.9 LTR.



813-2
GN 1/3 FOOD PAN 2.7 LTR.

VITRIFIED NON-POROUS
PORCELAIN FOOD PAN
EU 1935/2004 FOOD SAFE
STANDARD CONFORMED



P 823-2
GN 2/3 FOOD PAN 5.9 LTR.



P 823/2-2
DIVIDED GN 2/3 FOOD PAN 5.4 LTR.

CHOICE OF HEATING ELEMENTS :



EXTERNAL INDUCTION
DEVICE



FUEL



INDUCTION UNIT
GO WITH STAND



EXTERNAL ELECTRICAL
DEVICE

REGAL

GN 1/2

OBLONG CHAFING DISH

OPTIONAL GN 1/2 FOOD PAN 4.3 LTR.

W/ GLASS LID 



A-4521 L

DIMENSIONS

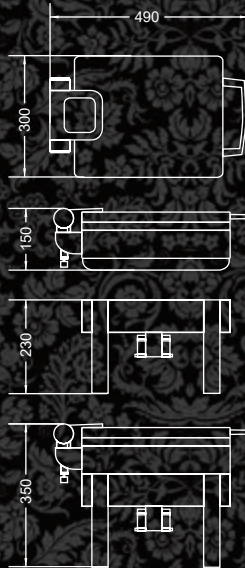

A-4521 L WITH STAND



STACKABLE DESIGN

- MATCHING STAND A-2021F

OPTIONAL ACCESSORIES:

CHROME-NICKEL STAINLESS STEEL
EU 1935/2004 FOOD SAFE
STANDARD CONFORMED



812-2
GN 1/2 FOOD PAN 4.3 LTR.

VITRIFIED NON-POROUS
PORCELAIN FOOD PAN
EU 1935/2004 FOOD SAFE
STANDARD CONFORMED



P 812-2
GN 1/2 FOOD PAN 4.3 LTR.

CHOICE OF HEATING

ELEMENTS :

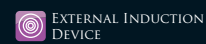



PRINCE

DELUXE INDUCTION CHAFING DISH

METROPOLITAN DESIGN AND SIMPLE SILHOUETTE, FORMING THE TOP CLASS IN ATHENA'S FAMILY. AN EVOLVED VERSION OF PATENTED HYDRAULIC HINGE IS APPLIED TO ALL MODELS IN THIS SERIES TO PROVIDE SMOOTH OPENING & SILENT CLOSING OF THE LID.

HEAVY GAUGE IN SHINY STAINLESS STEEL DEFINES IT'S QUALITY & DURABILITY. IT CAN BE USED DIRECTLY ON INDUCTION OR GO WITH MATCHING STAND FOR ELECTRIC OR CHAFER FUEL.

LID POSITION

- OPENS UP TO MAXIMUM 90°
- STAYS OPEN AT APPROX. 75°
- INITIATE TO CLOSE BY PRESSING DOWN GENTLY
- LID FALLS & CLOSSES AUTOMATICALLY & SILENTLY

NOISE STOPPER

- EASES NOISE OF CLOSING LID

WATER RETURN SYSTEM

- CONDENSATION FLOWS BACK TO WATER PAN INSTEAD OF FOOD

CONVENIENT NOTCH

- CHANGING FOOD PAN EASILY

CAPSULED BOTTOM

- MULTI-LAYER BOTTOM FOR FAST & EVEN HEATING

- 18/10 STAINLESS STEEL BODY
- WITH CAPSULED BOTTOM COMPATIBLE FOR INDUCTION, CHAFER FUEL AND ELECTRIC HEATER
- EU1935/2004 FOOD SAFE STANDARD CONFORMED

DETACHABLE LID

- FOR QUICK & EASY CLEANING

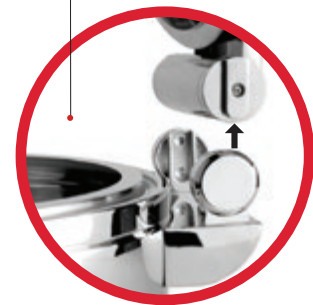

HYDRAULIC HINGE

- FOR SMOOTH OPENING & CLOSING OF LID

ADJUSTABLE LEVEL SUPPORT

- FOR A PERFECTLY LEVEL PLACEMENT WHEN REQUIRED



PRINCE ROUND

ROUND CHAFING DISH OPTIONAL 36CM FOOD PAN 6.1 LTR.

W/ GOLDEN ROSE LID 



A-2060-GR

W/ STEEL LID 



A-2060

W/ GLASS LID 



A-2060 L

DIMENSIONS

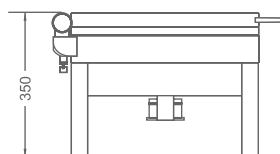
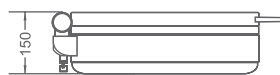
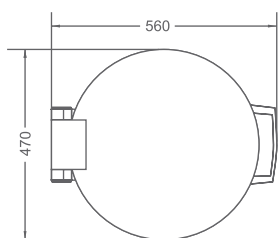

A-2060 WITH STAND



STACKABLE DESIGN

- MATCHING STAND A-2060F

OPTIONAL ACCESSORIES:

CHROME-NICKEL STAINLESS STEEL
EU 1935/2004 FOOD SAFE
STANDARD CONFORMED



RF 36-2
36CM ROUND FOOD PAN 6.1 LTR.



RF 36/ 2-2
DIVIDED 36CM ROUND FOOD PAN 5.8 LTR.

VITRIFIED NON-POROUS
PORCELAIN FOOD PAN
EU 1935/2004 FOOD SAFE
STANDARD CONFORMED



PRF 36-2
36CM ROUND FOOD PAN 6.1 LTR.



PRF 36/ 2-2
DIVIDED 36CM ROUND FOOD PAN 5.8 LTR.

CHOICE OF HEATING ELEMENTS :

 EXTERNAL INDUCTION
DEVICE

 FUEL

 INDUCTION UNIT
GO WITH STAND

 EXTERNAL ELECTRICAL
DEVICE

PRINCE

ROUND - SMALL

ROUND CHAFING DISH
OPTIONAL 28CM FOOD PAN 4.0 LTR.

W/ GOLDEN ROSE LID 



A-2040-GR

DIMENSIONS

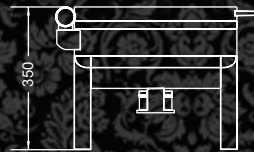
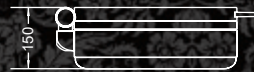
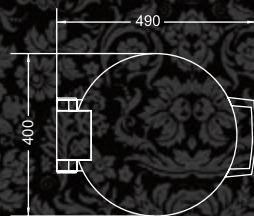

W/ STEEL LID 



A-2040

A-2040 WITH STAND



W/ GLASS LID 



A-2040 L



STACKABLE DESIGN

- MATCHING STAND A-2040F

OPTIONAL ACCESSORIES:

CHROME-NICKEL STAINLESS STEEL
EU 1935/2004 FOOD SAFE
STANDARD CONFORMED



RF 28-2
28CM ROUND FOOD PAN 4.0 LTR.

VITRIFIED NON-POROUS
PORCELAIN FOOD PAN
EU 1935/2004 FOOD SAFE
STANDARD CONFORMED



PRF 28-2
28CM ROUND FOOD PAN 4.0 LTR.



PRF 28-2/2
DIVIDED 28CM ROUND FOOD PAN 2.5 LTR.

CHOICE OF HEATING
ELEMENTS :



EXTERNAL INDUCTION
DEVICE



FUEL



INDUCTION UNIT
GO WITH STAND



EXTERNAL ELECTRICAL
DEVICE

PRINCE SOUP STATION

SOUP STATION
W/ 11 LTR. SOUP BUCKET

W/ GOLDEN ROSE LID 



A-20-11-GR

W/ STEEL LID 



A-20-11

W/ GLASS LID 



A-20-11 L

DIMENSIONS

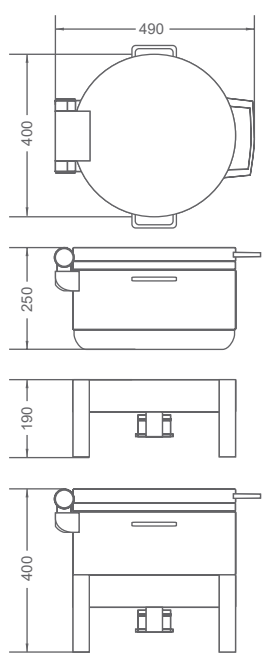

A-20-11 WITH STAND



- MATCHING STAND A-20-11F



CHOICE OF HEATING
ELEMENTS :

-  EXTERNAL INDUCTION DEVICE
-  FUEL
-  INDUCTION UNIT GO WITH STAND
-  EXTERNAL ELECTRICAL DEVICE

PRINCE

GN 1 /1

OBLONG CHAFING DISH

OPTIONAL GN 1/1 FOOD PAN 9.0 LTR.

W/ GOLDEN ROSE LID 



A-2011-GR

DIMENSION

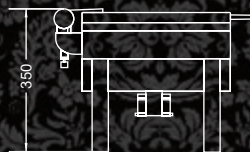
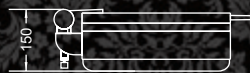
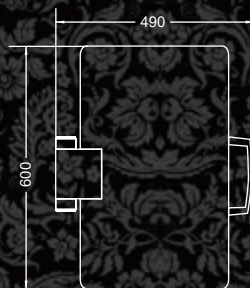

W/ STEEL LID 



A-2011

A-2011 WITH STAND



W/ GLASS LID 



A-2011 L



STACKABLE DESIGN

- MATCHING STAND A-2011F

OPTIONAL ACCESSORIES:

CHROME-NICKEL STAINLESS STEEL
EU 1935/2004 FOOD SAFE
STANDARD CONFORMED



811-2
GN 1/1 FOOD PAN 9.0 LTR.



812-2
GN 1/2 FOOD PAN 4.3 LTR.

VITRIFIED NON-POROUS
PORCELAIN FOOD PAN
EU 1935/2004 FOOD SAFE
STANDARD CONFORMED



P 811-2
GN 1/1 FOOD PAN 9.0 LTR.



P 812-2
GN 1/2 FOOD PAN 4.3 LTR.

CHOICE OF HEATING

ELEMENTS :



EXTERNAL INDUCTION
DEVICE



FUEL



INDUCTION UNIT
GO WITH STAND



EXTERNAL ELECTRICAL
DEVICE

PRINCE

GN 2/3

OBLONG CHAFING DISH

OPTIONAL GN 2/3 FOOD PAN 5.9 LTR.

W/ GOLDEN ROSE LID 



A-2032-GR

W/ STEEL LID 



A-2032

W/ GLASS LID 



A-2032 L

DIMENSIONS

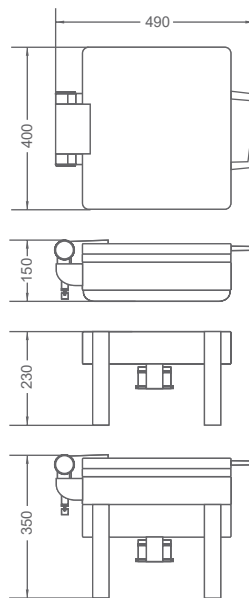

A-2032 WITH STAND



STACKABLE DESIGN

- MATCHING STAND A-2032F

OPTIONAL ACCESSORIES:

CHROME-NICKEL STAINLESS STEEL
EU 1935/2004 FOOD SAFE
STANDARD CONFORMED



823-2
GN 2/3 FOOD PAN 5.9 LTR.



813-2
GN 1/3 FOOD PAN 2.7 LTR.

VITRIFIED NON-POROUS
PORCELAIN FOOD PAN
EU 1935/2004 FOOD SAFE
STANDARD CONFORMED



P 823-2
GN 2/3 FOOD PAN 5.9 LTR.



P 823/2-2
DIVIDED GN 2/3 FOOD PAN 5.4 LTR.

CHOICE OF HEATING
ELEMENTS :



EXTERNAL INDUCTION
DEVICE



FUEL



INDUCTION UNIT
GO WITH STAND



EXTERNAL ELECTRICAL
DEVICE

PRINCE

GN 1/2

OBLONG CHAFING DISH

OPTIONAL GN 1/2 FOOD PAN 4.3 LTR.

W/ GOLDEN ROSE LID 



A-2021-GR

DIMENSIONS

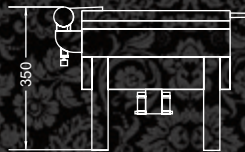
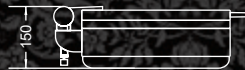
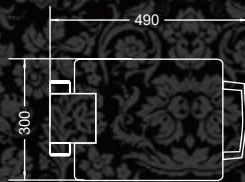

W/ STEEL LID 



A-2021

A-2021 WITH STAND



W/ GLASS LID 



A-2021 L



STACKABLE DESIGN

- MATCHING STAND A-2021F

OPTIONAL ACCESSORIES:

CHROME-NICKEL STAINLESS STEEL
EU 1935/2004 FOOD SAFE
STANDARD CONFORMED



812-2
GN 1/2 FOOD PAN 4.3 LTR.

VITRIFIED NON-POROUS
PORCELAIN FOOD PAN
EU 1935/2004 FOOD SAFE
STANDARD CONFORMED



P 812-2
GN 1/2 FOOD PAN 4.3 LTR.

CHOICE OF HEATING ELEMENTS :

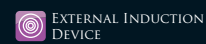

EXTERNAL INDUCTION
DEVICE



FUEL



INDUCTION UNIT
GO WITH STAND



EXTERNAL ELECTRICAL
DEVICE



PRINCESS

DELUXE INDUCTION CHAFING DISH

REFLECTS A PERFECT BLEND OF ELEGANT DESIGN AND PRACTICAL FUNCTION. THE DISH CAN GO BY ITSELF FOR QUICK & CONTEMPORARY SET UP OR ALONG WITH MATCHING STAND FOR A MORE CLASSIC ENVIRONMENT. COMMONLY USED HEATING SOURCES LIKE INDUCTION, ELECTRIC & CHAFER FUEL ARE ALL SUITABLE.

THE PATENTED HINGE MECHANISM ASSURES SMOOTH, GENTLE & SILENT OPENING & CLOSING OF LID- WHICH HELPS TO DEFINE THE CLASS OF A BUFFET.

LID POSITION

- OPENS UP TO MAXIMUM 90°
- STAYS OPEN AT APPROX. 75°
- INITIATE TO CLOSE BY PRESSING DOWN GENTLY
- LID FALLS & CLOSES AUTOMATICALLY & SILENTLY

NOISE STOPPER

- EASES NOISE OF CLOSING LID

WATER RETURN SYSTEM

- CONDENSATION FLOWS BACK TO WATER PAN INSTEAD OF FOOD

CAPSULED BOTTOM

- MULTI- LAYER BOTTOM FOR FAST & EVEN HEATING

- 18/10 STAINLESS STEEL BODY
- WITH CAPSULED BOTTOM COMPATIBLE FOR INDUCTION, CHAFER FUEL AND ELECTRIC HEATER
- EU1935/2004 FOOD SAFE STANDARD CONFORMED

DETACHABLE LID

- FOR QUICK & EASY CLEANING



BUFFER HINGE

- FOR SMOOTH OPENING & CLOSING OF LID

ADJUSTABLE LEVEL SUPPORT

- FOR A PERFECTLY LEVEL PLACEMENT WHEN REQUIRED

INSERT LIFTING PIN

- CHANGING FOOD PAN EASILY



PRINCESS GN 1/1

OBLONG CHAFING DISH
OPTIONAL GN 1/1 FOOD PAN 9.0 LTR.

DIMENSIONS

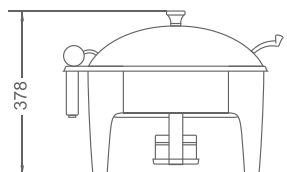
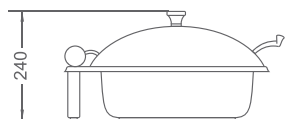
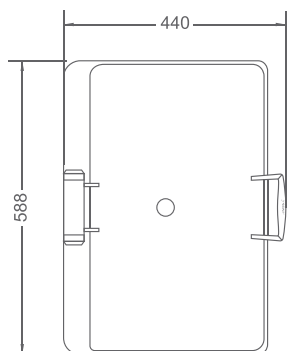

W/ GOLDEN ROSE LID 



A-1011-GR

W/ STEEL LID 



A-1011

W/ GLASS LID 



A-1011 L

AIR-VENT KNOB

A-1011-GR WITH STAND   



A-1011-GR
MATCHING STAND A-1011F

A-1011 WITH STAND   



A-1011
MATCHING STAND A-1011F

A-1011 L WITH STAND   



A-1011 L
MATCHING STAND A-1011F

AIR-VENT KNOB

OPTIONAL ACCESSORIES:

CHROME-NICKEL STAINLESS STEEL
EU 1935/2004 FOOD SAFE
STANDARD CONFORMED



811-2
GN 1/1 FOOD PAN 9.0 LTR.



812-2
GN 1/2 FOOD PAN 4.3 LTR.

VITRIFIED NON-POROUS
PORCELAIN FOOD PAN
EU 1935/2004 FOOD SAFE
STANDARD CONFORMED



P 811-2
GN 1/1 FOOD PAN 9.0 LTR.



P 812-2
GN 1/2 FOOD PAN 4.3 LTR.

CHOICE OF HEATING
ELEMENTS :

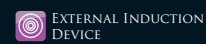

EXTERNAL INDUCTION
DEVICE



FUEL



INDUCTION UNIT
GO WITH STAND



EXTERNAL ELECTRICAL
DEVICE

PRINCESS GN 2/3

OBLONG CHAFING DISH
OPTIONAL GN 2/3 FOOD PAN 5.9 LTR.

DIMENSIONS

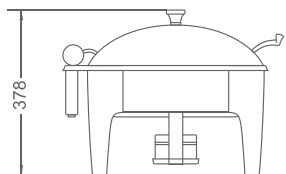
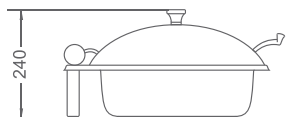
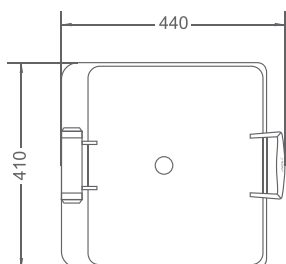

W/ GOLDEN ROSE LID 



A-1032-GR

W/ STEEL LID 



A-1032

W/ GLASS LID 



A-1032 L

AIR-VENT KNOB

A-1032-GR WITH STAND   



A-1032-GR
MATCHING STAND A-1032F

A-1032 WITH STAND   



A-1032
MATCHING STAND A-1011F

A-1032 L WITH STAND   



A-1032 L
MATCHING STAND A-1011F

AIR-VENT KNOB

OPTIONAL ACCESSORIES:

CHROME-NICKEL STAINLESS STEEL
EU 1935/2004 FOOD SAFE
STANDARD CONFORMED



823-2
GN 2/3 FOOD PAN 5.9 LTR.



813-2
GN 1/3 FOOD PAN 2.7 LTR.

VITRIFIED NON-POROUS
PORCELAIN FOOD PAN
EU 1935/2004 FOOD SAFE
STANDARD CONFORMED



P 823-2
GN 2/3 FOOD PAN 5.9 LTR.



P 823/2-2
DIVIDED GN 2/3 FOOD PAN 5.4 LTR.

CHOICE OF HEATING

ELEMENTS :



EXTERNAL INDUCTION
DEVICE



FUEL



INDUCTION UNIT
GO WITH STAND



EXTERNAL ELECTRICAL
DEVICE

PRINCESS GN 1/2

OBLONG CHAFING DISH OPTIONAL GN 1/2 FOOD PAN 4.3 LTR.

DIMENSIONS

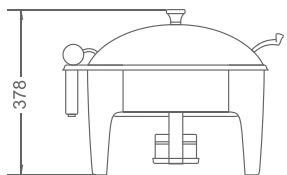
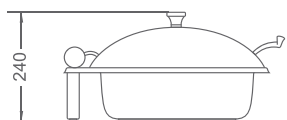
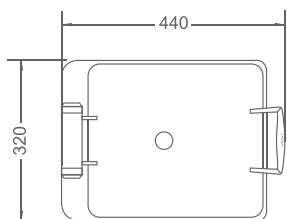

W/ GOLDEN ROSE LID 



A-1021-GR

W/ STEEL LID 





A-1021

W/ GLASS LID 



A-1021 L

AIR-VENT KNOB

A-1021-GR WITH STAND   



A-1021-GR
MATCHING STAND A-1021F

A-1021 WITH STAND   



A-1021
MATCHING STAND A-1021F

A-1021 L WITH STAND   



A-1021 L
MATCHING STAND A-1021F

AIR-VENT KNOB

OPTIONAL ACCESSORIES:

CHROME-NICKEL STAINLESS STEEL
EU 1935/2004 FOOD SAFE
STANDARD CONFORMED



812-2
GN 1/2 FOOD PAN 4.3 LTR.

VITRIFIED NON-POROUS
PORCELAIN FOOD PAN
EU 1935/2004 FOOD SAFE
STANDARD CONFORMED



P 812-2
GN 1/2 FOOD PAN 4.3 LTR.

CHOICE OF HEATING

ELEMENTS :

-  EXTERNAL INDUCTION DEVICE
-  FUEL
-  INDUCTION UNIT GO WITH STAND
-  EXTERNAL ELECTRICAL DEVICE

PRINCESS ROUND

ROUND CHAFING DISH
OPTIONAL 36CM FOOD PAN 6.1 LTR.

DIMENSIONS

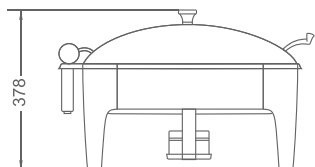
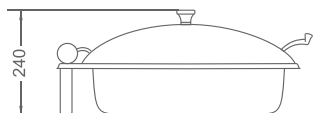
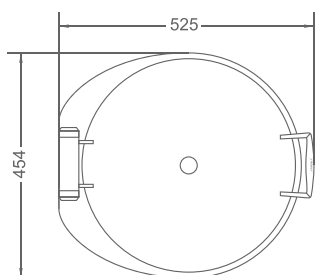

W/ GOLDEN ROSE LID 



A-1060-GR

W/ STEEL LID 



A-1060

W/ GLASS LID 



A-1060 L

AIR-VENT KNOB

A-1060-GR WITH STAND   



A-1060-GR
MATCHING STAND A-1060F

A-1060 WITH STAND   



A-1060
MATCHING STAND A-1060F

A-1060 L WITH STAND   



A-1060 L
MATCHING STAND A-1060F

AIR-VENT KNOB

OPTIONAL ACCESSORIES:

CHROME-NICKEL STAINLESS STEEL
EU 1935/2004 FOOD SAFE
STANDARD CONFORMED



RF 36-2
36CM ROUND FOOD PAN 6.1 LTR.



RF 36/ 2-2
DIVIDED 36CM ROUND FOOD PAN 5.8 LTR.

VITRIFIED NON-POROUS
PORCELAIN FOOD PAN
EU 1935/2004 FOOD SAFE
STANDARD CONFORMED



PRF 36-2
36CM ROUND FOOD PAN 6.1 LTR.



PRF 36/ 2-2
DIVIDED 36CM ROUND FOOD PAN 5.8 LTR.

**CHOICE OF HEATING
ELEMENTS :**

-  EXTERNAL INDUCTION
DEVICE
-  FUEL
-  INDUCTION UNIT
GO WITH STAND
-  EXTERNAL ELECTRICAL
DEVICE

PRINCESS SOUP STATION

SOUP STATION
W/ 11 LTR. SOUP BUCKET

DIMENSIONS

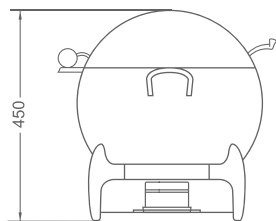
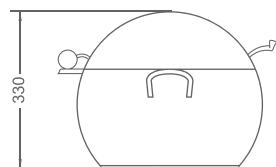
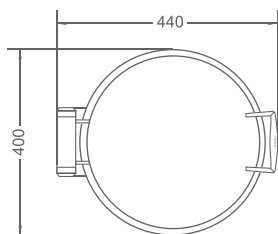

W/ GOLDEN ROSE LID 



A-10-11-GR

A-10-11-GR WITH STAND  



A-10-11-GR
MATCHING STAND A-10-11F

W/ STEEL LID 



A-10-11

A-10-11 WITH STAND  



A-10-11
MATCHING STAND A-10-11F

W/ GLASS LID 



AIR-VENT KNOB

A-10-11 L

A-10-11 L WITH STAND  



A-10-11 L
MATCHING STAND A-10-11F

CHOICE OF HEATING

ELEMENTS :

 EXTERNAL INDUCTION
DEVICE

 FUEL

 INDUCTION UNIT
GO WITH STAND

IMPERIAL REGENCY & METRO

DELUXE BUFFER HINGED ROLL TOP CHAFING DISH

MAKE USE OF A PAIR OF MINI-BUFFER HINGE WHICH CONTROL THE SPEED AND STRENGTH OF THE LID MOTION TO ENSURE A SMOOTH AND SILENT OPERATION. THE LID IS DETACHABLE FOR EASY CLEANING AND FEATURED WITH WATER RETURN SYSTEM.

TWO CHOICES OF HANDLE AND LEG ARE AVAILABLE - OFFERING MATCHING OPTIONS FOR DIFFERENT BUFFET SETTINGS. BOTH DESIGNS ARE STACKABLE FOR EASY STORAGE.



IMPERIAL REGENCY

DELUXE BUFFER
HINGED ROLL TOP
CHAFING DISH

OPTIONAL ACCESSORIES:

CHROME-NICKEL STAINLESS STEEL
EU 1935/2004 FOOD SAFE
STANDARD CONFORMED



RF 36-2
36CM ROUND FOOD PAN 6.1 LTR.



RF 36/ 2-2
DIVIDED 36CM ROUND FOOD PAN 5.8 LTR.

VITRIFIED NON-POROUS
PORCELAIN FOOD PAN

EU 1935/2004 FOOD SAFE
STANDARD CONFORMED



PRF 36-2
36CM ROUND FOOD PAN 6.1 LTR.



PRF 36/ 2-2
DIVIDED 36CM ROUND FOOD PAN 5.8 LTR.

CHOICE OF HEATING
ELEMENTS :



A-1031S

- ROUND BUFFER HINGED ROLL TOP CHAFING DISH WITH STAINLESS STEEL LEGS
- COMPLETED WITH 6.1 LTR. FOOD PAN & FUEL HOLDER

STACKABLE DESIGN



STACKABLE DESIGN



STAYS OPEN AT 90°



FULLY OPEN AT 180°

A-1030S

- ROUND BUFFER HINGED ROLL TOP SOUP STATION WITH STAINLESS STEEL LEGS
- COMPLETED WITH 10.0 LTR. SOUP BUCKET & FUEL HOLDER

STACKABLE DESIGN



FULLY OPEN AT 180°





ACCESSORIES:



A-1030SB
SOUP BUCKET 10.0 LTR FOR A-1030S



AP-04
ADAPTING PLATE FOR A-1030S

A-1033S  

- GN 1/1 BUFFER HINGED ROLL TOP CHAFING DISH WITH STAINLESS STEEL LEGS
- COMPLETED WITH 9.0 LTR. FOOD PAN & FUEL HOLDERS

STACKABLE DESIGN



STAYS OPEN AT 90°



STACKABLE DESIGN



FULLY OPEN AT 180°

A-1038S  

- GN 1/1 BUFFER HINGED ROLL TOP SOUP STATION WITH STAINLESS STEEL LEGS
- COMPLETED WITH 2x4.5 LTR. SOUP BUCKET & FUEL HOLDERS

STACKABLE DESIGN



ACCESSORIES:



FULLY OPEN AT 180°



A-1038SB
SOUP BUCKET 4.5 LTR FOR A-1038S



AP-03
ADAPTING PLATE FOR A-1038S

OPTIONAL ACCESSORIES:

CHROME-NICKEL STAINLESS STEEL
EU 1935/2004 FOOD SAFE
STANDARD CONFORMED



811-2
GN 1/1 FOOD PAN 9.0 LTR.



812-2
GN 1/2 FOOD PAN 4.3 LTR.

VITRIFIED NON-POROUS
PORCELAIN FOOD PAN
EU 1935/2004 FOOD SAFE
STANDARD CONFORMED



P 811-2
GN 1/1 FOOD PAN 9.0 LTR.



P 812-2
GN 1/2 FOOD PAN 4.3 LTR.

METRO

DELUXE BUFFER HINGED ROLL TOP CHAFING DISH

OPTIONAL ACCESSORIES:

CHROME-NICKEL STAINLESS STEEL
EU 1935/2004 FOOD SAFE
STANDARD CONFORMED



RF 36-2
36CM ROUND FOOD PAN 6.1 LTR.



RF 36/ 2-2
DIVIDED 36CM ROUND FOOD PAN 5.8 LTR.

VITRIFIED NON-POROUS
PORCELAIN FOOD PAN
EU 1935/2004 FOOD SAFE
STANDARD CONFORMED



PRF 36-2
36CM ROUND FOOD PAN 6.1 LTR.



PRF 36/ 2-2
DIVIDED 36CM ROUND FOOD PAN 5.8 LTR.

CHOICE OF HEATING
ELEMENTS :



A-1031B

- ROUND BUFFER HINGED ROLL TOP CHAFING DISH WITH TUBULAR LEGS
- COMPLETED WITH 6.1 LTR. FOOD PAN & FUEL HOLDER

STACKABLE DESIGN



STAYS OPEN AT 90°



FULLY OPEN AT 180°



STACKABLE DESIGN

A-1030B

- ROUND BUFFER HINGED ROLL TOP SOUP STATION WITH TUBULAR LEGS
- COMPLETED WITH 10.0 LTR. SOUP BUCKET & FUEL HOLDER

STACKABLE DESIGN



ACCESSORIES:



A-1030SB
SOUP BUCKET 10.0 LTR FOR A-1030B



AP-04
ADAPTING PLATE FOR A-1030B



FULLY OPEN AT 180°

A-1033B  

- GN 1/1 BUFFER HINGED ROLL TOP CHAFING DISH WITH TUBULAR LEGS
- COMPLETED WITH 9.0 LTR. FOOD PAN & FUEL HOLDERS

STACKABLE DESIGN



STAYS OPEN AT 90°



STACKABLE DESIGN



FULLY OPEN AT 180°

OPTIONAL ACCESSORIES:

CHROME-NICKEL STAINLESS STEEL
EU 1935/2004 FOOD SAFE
STANDARD CONFORMED



811-2
GN 1/1 FOOD PAN 9.0 LTR.



812-2
GN 1/2 FOOD PAN 4.3 LTR.

A-1038B  

- GN 1/1 BUFFER HINGED ROLL TOP SOUP STATION WITH TUBULAR LEGS
- COMPLETED WITH 2x4.5 LTR. SOUP BUCKET & FUEL HOLDERS

STACKABLE DESIGN



ACCESSORIES:



FULLY OPEN AT 180°



A-10385B
SOUP BUCKET 4.5 LTR FOR A-1038B



AP-03
ADAPTING PLATE FOR A-1038B

VITRIFIED NON-POROUS
PORCELAIN FOOD PAN
EU 1935/2004 FOOD SAFE
STANDARD CONFORMED



P 811-2
GN 1/1 FOOD PAN 9.0 LTR.



P 812-2
GN 1/2 FOOD PAN 4.3 LTR.



OPTIONAL ACCESSORIES:

VITRIFIED NON-POROUS
PORCELAIN FOOD PAN
EU 1935/2004 FOOD SAFE
STANDARD CONFORMED



FP-1000
DISCONTINUED PAN 1.0 LTR.



SP-1500
DISCONTINUED PAN 1.5 LTR.



SP-2500
DISCONTINUED PAN 2.5 LTR.

IMPERIAL MINI

ELEGANT AND COMPACT, AVAILABLE
IN 3 CAPACITIES, IDEAL CHOICE
FOR SMALL EVENTS AND EXECUTIVE
LOUNGE WITH LIMITED SPACE



LID POSITION
– OPENS UP TO MAXIMUM 95°



MINI SOUP TUREEN **DISCONTINUED**
AST-01.2500/ 2.5L
OPTIONAL 2.5L PORCELAIN SAUCE PAN
SP-2500



SAUCE TUREEN **DISCONTINUED**
AST-01.1500/ 1.5L
OPTIONAL 1.5L PORCELAIN SAUCE PAN
SP-1500



MINI CHAFING DISH **DISCONTINUED**
AST-01.1000/ 1L
OPTIONAL 1.0L PORCELAIN FOOD PAN
FP-1000

DISPENSERS



FRONT: IMPERIAL 11L COFFEE URN
ACU-01.11000
MIDDLE: KOOL 5L JUICE DISPENSER
AJD-03.5000
BACK: METRO 6L MILK DISPENSER
AMD-02.6000



IMPERIAL

CASTED ALLOY LEGS

MILK DISPENSER

JUICE DISPENSER



AMD-01.6000/ 6L



AJD-01.8000/ 8L

COFFEE URN  



ACU-01.11000/ 11L



ACU-01.20000/ 20L

CHOICE OF HEATING ELEMENTS :  FUEL  INDUCTION UNIT GO WITH STAND

METRO

STEEL BASE

MILK DISPENSER



AMD-02.6000/ 6L

JUICE DISPENSER



AJD-02.8000/ 8L

CEREAL DISPENSER



ACD-02.8000/ 8L

KOOL

NATURAL ACACIA BASE

MILK DISPENSER



AMD-03.4000/ 4L

JUICE DISPENSER



AJD-03.5000/ 5L

CHOICE OF HEATING ELEMENT



- PRINCESS GN 1/1 W/ STAND
- PRINCE GN 1/1 W/ STAND
- REGAL GN 1/1 W/ STAND



- PRINCESS GN 2/3 W/ STAND
- PRINCE GN 2/3 W/ STAND
- REGAL GN 2/3 W/ STAND



- PRINCESS GN 1/2 W/ STAND
- PRINCE GN 1/2 W/ STAND
- REGAL GN 1/2 W/ STAND



- PRINCESS ROUND W/ STAND
- PRINCE ROUND W/ STAND
- PRINCE SMALL ROUND W/ STAND
- REGAL ROUND W/ STAND
- REGAL SMALL ROUND W/ STAND



- PRINCESS GN 1/1
- PRINCE GN 1/1
- REGAL GN 1/1



- PRINCESS GN 2/3
- PRINCE GN 2/3
- REGAL GN 2/3



- PRINCESS GN 1/2
- PRINCE GN 1/2
- REGAL GN 1/2



• PRINCESS GN 1/1 W/ STAND



• PRINCESS GN 2/3 W/ STAND



• PRINCESS GN 1/2 W/ STAND



• PRINCESS ROUND W/ STAND



- PRINCE GN 1/1 W/ STAND
- REGAL GN 1/1 W/ STAND



- PRINCE GN 2/3 W/ STAND
- REGAL GN 2/3 W/ STAND



- PRINCE GN 1/2 W/ STAND
- REGAL GN 1/2 W/ STAND



- PRINCE ROUND W/ STAND
- PRINCE SMALL ROUND W/ STAND
- REGAL ROUND W/ STAND
- REGAL SMALL ROUND W/ STAND



• PRINCESS SOUP STATION W/ STAND

+



AP-10-11P
ADAPTING PLATE



HL-C10K



COMPACT INDUCTION WARMER
Ø 245MM × 65MM(H)
1000W, 220V - 240V



• IMPERIAL 11L COFFEE URN



• IMPERIAL 20L COFFEE URN



A-FH-01



FUEL HOLDER
Ø 90 MM × 60MM(H)



- PRINCESS SOUP STATION W/ STAND
- PRINCE SOUP STATION W/ STAND
- REGAL SOUP STATION W/ STAND



• IMPERIAL REGENCY CHAFING DISH



• METRO CHAFING DISH



A-FH-01



FUEL HOLDER
Ø 90MM × 60MM(H)



- PRINCESS ROUND
- PRINCE ROUND
- PRINCE SMALL ROUND



- REGAL ROUND
- REGAL SMALL ROUND



- PRINCESS SOUP STATION
- PRINCE SOUP STATION
- REGAL SOUP STATION



A-I-2000B

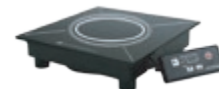

INDUCTION COOKER, BUILT-IN TYPE
W/ EXTENDED CONTROL PANEL
300MM × 300MM × 75MM(H)
1800W, 110V OR 220V



AP-01
ADAPTING PLATE



A-HP-002



ELECTRICAL WARMER
300MM × 200MM × 20MM(H)
700W, 110V OR 220V



HL-C10K



COMPACT INDUCTION WARMER
Ø 245MM × 65MM(H)
1000W, 220V - 240V



- PRINCE SOUP STATION W/ STAND
- REGAL SOUP STATION W/ STAND



A-200H-F



ELECTRICAL WARMER
255MM × 200MM × 20MM(H)
500W, 110V OR 220V



HL-C10K



COMPACT INDUCTION WARMER
Ø 245MM × 65MM(H)
1000W, 220V - 240V



• IMPERIAL REGENCY CHAFING DISH



• METRO CHAFING DISH



AP-02
ADAPTING PLATE



HL-C10K



COMPACT INDUCTION WARMER
Ø 245MM × 65MM(H)
1000W, 220V - 240V



• IMPERIAL 11L COFFEE URN



A-HC-C05H



COMPACT INDUCTION WARMER
Ø 180MM × 75MM(H)
800W, 110V OR 220V



• IMPERIAL 20L COFFEE URN



HL-C10K



COMPACT INDUCTION WARMER
Ø 245MM × 65MM(H)
1000W, 220V - 240V





NEW

3 TIERS AFTERNOON TEA STAND
TOP-80/ 365×300×505(H)MM
(FITS 10" PLATE, PLATE
NOT INCLUDED)

NORDICA

NEW DESIGN AFTERNOON TEA STAND WITH A TOUCH OF HAMMERING HANDICRAFT AND A SENSE FROM GREEN GARDEN. AVAILABLE IN THREE SIZES, FIT PERFECTLY WITH 6, 8, AND 10 INCHES PLATES RESPECTIVELY.

NEW

3 TIERS AFTERNOON TEA STAND
TOP-79/ 315×245×450(H)MM
(FITS 8" PLATE, PLATE NOT INCLUDED)



NEW

2 TIERS AFTERNOON TEA STAND
TOP-78/ 230×200×275(H)MM
(FITS 6" PLATE, PLATE NOT INCLUDED)

MANDARIN

3 TIERS AFTERNOON TEA STAND
TOP-67 / Ø230×460(H)MM
(FITS 8" PLATE, PLATE NOT INCLUDED)



2 TIERS AFTERNOON TEA STAND
TOP-66 / **DISCONTINUED**
(FITS 6" PLATE, PLATE NOT INCLUDED)



AFTERNOON TEA

SPEND YOUR LEISURE TIME IN STYLE

RING 3 TIERS HIGH TEA STAND

MORE COLOUR
CHOICE:

MORE COLOUR
CHOICE:



TOP-39/ Ø306×453(H)MM
(FITS 10" PLATE, PLATE NOT
INCLUDED)

TOP-39-BLK/ **DISCONTINUED**
(FITS 10" PLATE, PLATE NOT
INCLUDED)

TOP-08/ Ø230×408(H)MM
(FITS 8" PLATE, PLATE NOT
INCLUDED)

TOP-08-BLK/ **DISCONTINUED**
(FITS 8" PLATE, PLATE NOT
INCLUDED)

CORTE PORCELAIN BOWL

IMPERIAL BUTTER DISH SET

LEXI TEA STRAINER

SCISSOR PASTRY TONGS



GH-57/ Ø50×25(H)MM
GH-14/ Ø70×40(H)MM



TOP-02/ Ø78×67(H)MM



TOP-13/ Ø65×86(H)MM



BU-20/ 212MM

KUBA JAM TRAY, 3 BOTTLES

KUBA JAM TRAY, 4 BOTTLES

RING JAM STAND

RING HONEY STAND



TOP-65/ 151×80×9(H)MM



TOP-63/ 93×93×9(H)MM



TOP-15/ 160×56×150(H)MM



TOP-16/ 160×56×90(H)MM

MESSINA



MESSINA MILK JUG



SMJ-03.20/ 0.20L



SMJ-03.15/ 0.15L



SSB-03.20/ 0.20L

MESSINA COFFEE/ TEA POT



STP-03.50/ 0.50L



STP-03.80/ 0.80L



FEATURING:

- ① STR-02 DORF COFFEE TRAY/ 192x118x15(H)MM
- ② SMJ-03.15 MESSINA MILK JUG/ 0.15L
- ③ SSB-03.20 MESSINA SUGAR BOWL/ 0.20L
- ④ 805-CS VINCI COFFEE SPOON/ 115MM

MANDARIN

SEE THE TEA LEAVES AND FLOWERS DEVELOP THROUGH THE CRYSTAL CLEAR TEAPOT BODY, BREW UP TO YOUR OWN TASTE WHILE ENJOYING THE VISUAL. EASY TO CLEAN. HANDMADE WITH BUBBLE-LESS BOROSILICATE GLASS.



MANDARIN TEA POT WITH GLASS INFUSER **Handmade**



GTP-07.50/ 0.50L



GTP-07.100/ 1L



MANDARIN TEA CUP ^ **Handmade**



GDC-07.10/ 0.10L

LOTUS TEA WARMER



TOP-73/ 164x164x45(H)MM

LEXI TEA STRAINER



TOP-13/ ø65x86(H)MM

^ WOODEN TRAY IS NOT INCLUDED

ATHENA OFFERS A RANGE OF BOROSILICATE
HANDMADE GLASSWARE WHICH IS
TRANSPARENT, EXTRA STRONG AND LIGHT.
LOOK AT EACH PIECE YOU MAY OBSERVE
A UNIQUE TOUCH BECAUSE EVERY
SINGLE PIECE IS CAREFULLY MOUTH BLOWN
BY A SKILLFUL CRAFTSMAN.



DORF

DORF COFFEE PRESS



GCP-01.35/ 0.35L



GCP-01.50/ 0.50L



GCP-01.100/ 1L

DORF DOUBLE WALL THERMO GLASS *Handmade*



GDG-03.10/ 0.10L



GDG-03.22/ 0.22L



GDG-03.25/ 0.25L



GDG-03.30/ 0.30L

STAINLESS STEEL SAUCER



SAU-04.115/ Ø115MM



SAU-04.132/ Ø132MM



SAU-04.149/ Ø149MM



SAU-04.158/ Ø158MM

THERMO DOUBLE WALL GLASS IS THE LATEST TREND OF GLASSWARE FOR SERVING COLD & HOT DRINKS. THANKS TO THE DOUBLE-WALL FEATURE, DRINKS CAN NOW STAY COOL OR HOT MUCH LONGER THAN BEFORE, WHILE KEEPING YOUR HANDS COMFORTABLE.

LEXI

LEXI TEA POT WITH S/S INFUSER **Handmade**



GTP-02.35/ 0.35L



GTP-02.60/ 0.60L



GTP-02.100/ 1L

LEXI DOUBLE WALL THERMO GLASS **Handmade**



GDG-01.10/ 0.10L



GDG-01.22/ 0.22L



GDG-01.25/ 0.25L



GDG-01.30/ 0.30L

LEXI SUGAR BOWL ^ WITH S/S LID



GSB-01.20/ **DISCONTINUED**

LEXI MILK JUG



GMJ-01.18/ **DISCONTINUED**

LEXI DOUBLE WALL THERMO GLASS **Handmade**



GDC-01.10/ 0.10L



GDC-01.22/ 0.22L

^ SPOON IS NOT INCLUDED

NOVA

NOVA, OUR NEW RANGE OF DOUBLE WALL GLASS FEATURED WITH HANDLE TO GO WITH STAINLESS STEEL SAUCER FOR A CLASSIC TOUCH OF HIGH TEA.



NOVA DOUBLE WALL THERMO GLASS WITH SAUCER **Handmade**



GDC-04.10/ **DISCONTINUED**



GDC-04.22/ **DISCONTINUED**



GDC-04.25/ **DISCONTINUED**



GDC-04.30/ **DISCONTINUED**

NOVA DOUBLE WALL THERMO GLASS **Handmade**



GDC-04.10/ **DISCONTINUED**



GDC-04.22/ **DISCONTINUED**



GDC-04.25/ **DISCONTINUED**



GDC-04.30/ **DISCONTINUED**

STAINLESS STEEL SAUCER



SAU-04.115/ Ø115MM



SAU-04.132/ Ø132MM



SAU-04.149/ Ø149MM



SAU-04.158/ Ø158MM



LYNDON

PROFESSIONALLY CRAFTED SERIES
 IN PRECISE SHAPE, GAUGE AND
 CAPACITY. PERFECT FOR
 HIGH VOLUME MODERN CAFES.

ESPRESSO/ 0.08L CUP/ Ø120MM SAUCER



CAFE LATTE/ 0.20L CUP/ Ø145MM SAUCER



CAPPUCCINO/ 0.30L CUP/ Ø160MM SAUCER



- 1 SET: CW-301.08/SAU
CUP: CW-301.08 **DISCONTINUED**
- 2 SET: CW-301.08-YEL/SAU
CUP: CW-301.08-YEL **DISCONTINUED** -YEL
- 3 SET: CW-301.08-TUR/SAU
CUP: CW-301.08-TUR **DISCONTINUED** -TUR
- 4 SET: CW-301.08-RED/SAU
CUP: CW-301.08-RED **DISCONTINUED** -RED
- 5 SET: CW-301.08-BLK/SAU
CUP: CW-301.08-BLK **DISCONTINUED** -BLK

- 6 SET: CW-301.20/SAU
CUP: CW-301.20 **DISCONTINUED** 5
- 7 SET: CW-301.20-YEL/SAU
CUP: CW-301.20-YEL **DISCONTINUED** -YEL
- 8 SET: CW-301.20-TUR/SAU
CUP: CW-301.20-TUR **DISCONTINUED** -TUR
- 9 SET: CW-301.20-RED/SAU
CUP: CW-301.20-RED **DISCONTINUED** -RED
- 10 SET: CW-301.20-BLK/SAU
CUP: CW-301.20-BLK **DISCONTINUED** -BLK

- 11 SET: CW-301.30/SAU
CUP: CW-301.30 **DISCONTINUED** D
- 12 SET: CW-301.30-YEL/SAU
CUP: CW-301.30-YEL **DISCONTINUED** -YEL
- 13 SET: CW-301.30-TUR/SAU
CUP: CW-301.30-TUR **DISCONTINUED** -TUR
- 14 SET: CW-301.30-RED/SAU
CUP: CW-301.30-RED **DISCONTINUED** -RED
- 15 SET: CW-301.30-BLK/SAU
CUP: CW-301.30-BLK **DISCONTINUED** -BLK

COMBINATIONS

ATHENA COFFEE & TEA ACCESSORIES
 LINK UP THE WHOLE FAMILY AND PRESENT
 AMAZING COMBINATIONS TO SERVE.



FEATURING:

- ① STR-02 DORF COFFEE TRAY/ 192×118×15(H)MM
- ② CW-301.08-BLK LYNDON ESPRESSO CUP/BLACK/ 0.08L
- ③ BORMIOLI ROCCO 383470 ZENO WATER GLASS/ 0.26L
- ④ 808-CS HUGO COFFEE SPOON/ 110MM

MORE COLOUR CHOICES:



FEATURING:

- ① STR-02 DORF COFFEE TRAY/ 192×118×15(H)MM
- ② CW-301.20 LYNDON LATTE CUP/ WHITE/ 0.20L
- ③ BORMIOLI ROCCO 383470 ZENO WATER GLASS/ 0.26L
- ④ 808-ET HUGO TEA SPOON/ 142MM

MORE COLOUR CHOICES:



FEATURING:

- ① STR-02 DORF COFFEE TRAY/ 192×118×15(H)MM
- ② CW-301.30-YEL LYNDON CAPPUCCINO CUP/ YELLOW/ 0.30L
- ③ BORMIOLI ROCCO 383470 ZENO WATER GLASS/ 0.26L
- ④ 808-ET HUGO TEA SPOON/ 142MM

MORE COLOUR CHOICES:





FEATURING:

- ① STR-02 DORF COFFEE TRAY/ 192×118×15(H)MM
- ② GDC-04.10 NOVA DOUBLE WALL THERMO GLASS/ 0.10L
- ③ 848-CS CHESA COFFEE SPOON/ 115MM

MORE GLASS CHOICES:



FEATURING:

- ① STR-02 DORF COFFEE TRAY/ 192×118×15(H)MM
- ② SMJ-03.15 MESSINA MILK JUG/ 0.15L
- ③ SSB-03.20 MESSINA SUGAR BOWL/ 0.20L
- ④ 805-CS VINCI COFFEE SPOON/ 115MM



FEATURING:

- ① STR-02 DORF COFFEE TRAY/ DISCONTINUED
- ② SMJ.NM-02.20 SPHERES MILK JUG WITH S/S HANDLE/ DISCONTINUED
- ③ SSB.NM-02.20 SPHERES SUGAR BOWL WITH S/S HANDLE/ DISCONTINUED



FEATURING:

- ① STR-02 DORF COFFEE TRAY/ 192×118×15(H)MM
- ② GMJ-01.18 LEXI MILK JUG/ 0.18L
- ③ GSB-01.20 LEXI SUGAR BOWL WITH S/S LID/ 0.20L
- ④ 806-CS ROYCE COFFEE SPOON/ 110MM



FEATURING:

- ① TR-904 DORF WOODEN TRAY/ 170×100×22(H)MM
- ② GDG-03.10 DORF DOUBLE WALL THERMO GLASS/ 0.10L
- ③ 848-CS CHESA COFFEE SPOON/ 115MM



FEATURING:

- ① TR-905 DORF WOODEN TRAY/ 185×120×22(H)MM
- ② GDC-01.22 LEXI DOUBLE WALL THERMO GLASS/ 0.22L
- ③ 848-ET CHESA TEA SPOON/ 140MM



SUGAR SET/ CB-61.3, CONSISTING OF:

- ① TR-1002 TOKYO WOODEN TRAY/ DISCONTINUED
- ② 2PCS OF GH-46 DOLCE S/S BOWL/ DISCONTINUED
(FEATURING SUGAR TONGS BU-19, NOT INCLUDED IN SET)



FEATURING:

- ① TR-903 DORF WOODEN TRAY/ 325×120×22(H)MM
- ② GDC-01.22 LEXI DOUBLE WALL THERMO GLASS/ 0.22L
- ③ 848-ET CHESA TEA SPOON/ 140MM
- ④ GH-46 DOLCE S/S BOWL/ 90×60×35(H)MM



COCKTAIL & BARWARE

IMPERIAL

THE RANGE OF TRAYS DESIGNED TO DISPLAY SAVORY, PETIT FOUR, SWEET AND COLD CUT. EACH SIZED THOUGHTFULLY, IN SHINY FINISH TO ADD ELEGANCE FOR EVENTS.

IMPERIAL BANQUET TRAY



STR-18 / 530 x 325 x 25(H)MM



STR-19 / 600 x 400 x 25(H)MM



STR-20 / 645 x 525 x 25(H)MM



CAMEO

CAMEO SERVING TRAY - RUSTIC SMALL ROUND TRAYS TO SERVE SAVORY, PETIT FOUR AND SWEETS THROUGHOUT THE COCKTAIL EVENT.

CAMEO WOODEN TRAY



TR-20.182R/
Ø182×22(H)MM



TR-20.252R/
Ø252×30(H)MM



TR-20.300R/
Ø300×40(H)MM

CASSANDRA DELUXE PUNCH BOWL



BW-19/ Ø440×305(H)MM

PARTY HELPER



FEATURING:

- 1 848-DSP CHESA DESSERT SPORK/ **DISCONTINUED**
- 2 BW-23 CLIP N GRAB PARTY HELPER/ 180×136MM
- BW-34 CLIP N GRAB PARTY HELPER/ 102×84MM



ZOIE GOURMET BOTTLE



FEATURING:

- 1 GW-302.25 ZOIE GOURMET BOTTLE/ 200(H)MM 0.25L
- 2 TOP-11 DOLCE S/S BOWL/ Ø100×40(H)MM

CASSANDRA TEST TUBE TRAY

"FUN" IS THE MAGIC WORD - LET'S PUSH IT HIGHER BY DRINKING WITH TEST TUBES.



1 TEST TUBE STATION BW-32 ^/ 258x86x100(H)MM REVERSILBE, FITS 12 PCS OF SMALL OR LARGE TEST TUBE



2 ZOIE TEST TUBE/ GW-401 Ø22x172(H)MM/ 0.04L

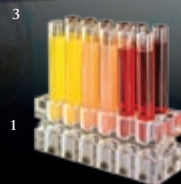

3 ZOIE TEST TUBE/ GW-402 Ø28x193(H)MM/ 0.08L

1 TEST TUBE STATION BW-22 ^/ 485x86x100(H)MM REVERSILBE, FITS 24 PCS OF SMALL OR LARGE TEST TUBE



2 ZOIE TEST TUBE/ GW-401 Ø22x172(H)MM/ 0.04L



3 ZOIE TEST TUBE/ GW-402 Ø28x193(H)MM/ 0.08L

CASSANDRA TEST TUBE TRAY FITS 12 PCS OF SMALL OR LARGE TEST TUBE WITH DETACHABLE HANDLE. BASKET - TRAY CONVERTIBLE



BW-21/ Ø268MM

CHEERS

YOUR SMALL COMPANIONS
IN HAPPY HOURS

DOLCE STAINLESS STEEL BOWL



TOP-11/ \varnothing 100x40(H)MM



TOP-12/ \varnothing 77x30(H)MM



GH-48/ 120x80x47(H)MM



GH-46/ 90x60x35(H)MM

REECE 3-LEAF SNACK BOWL/ 190x182x44(H)MM



CW-003-RED/ **DISCONTINUED**



CW-003-EGP/ **DISCONTINUED**



CW-003-OLI/ **DISCONTINUED**



CW-003-WGR/ **DISCONTINUED**

LEXI DOUBLE WALL BEER GLASS



GDG-01.21/ 0.21L



GDG-01.35/ 0.35L



GDG-01.47/ 0.47L



JASPER

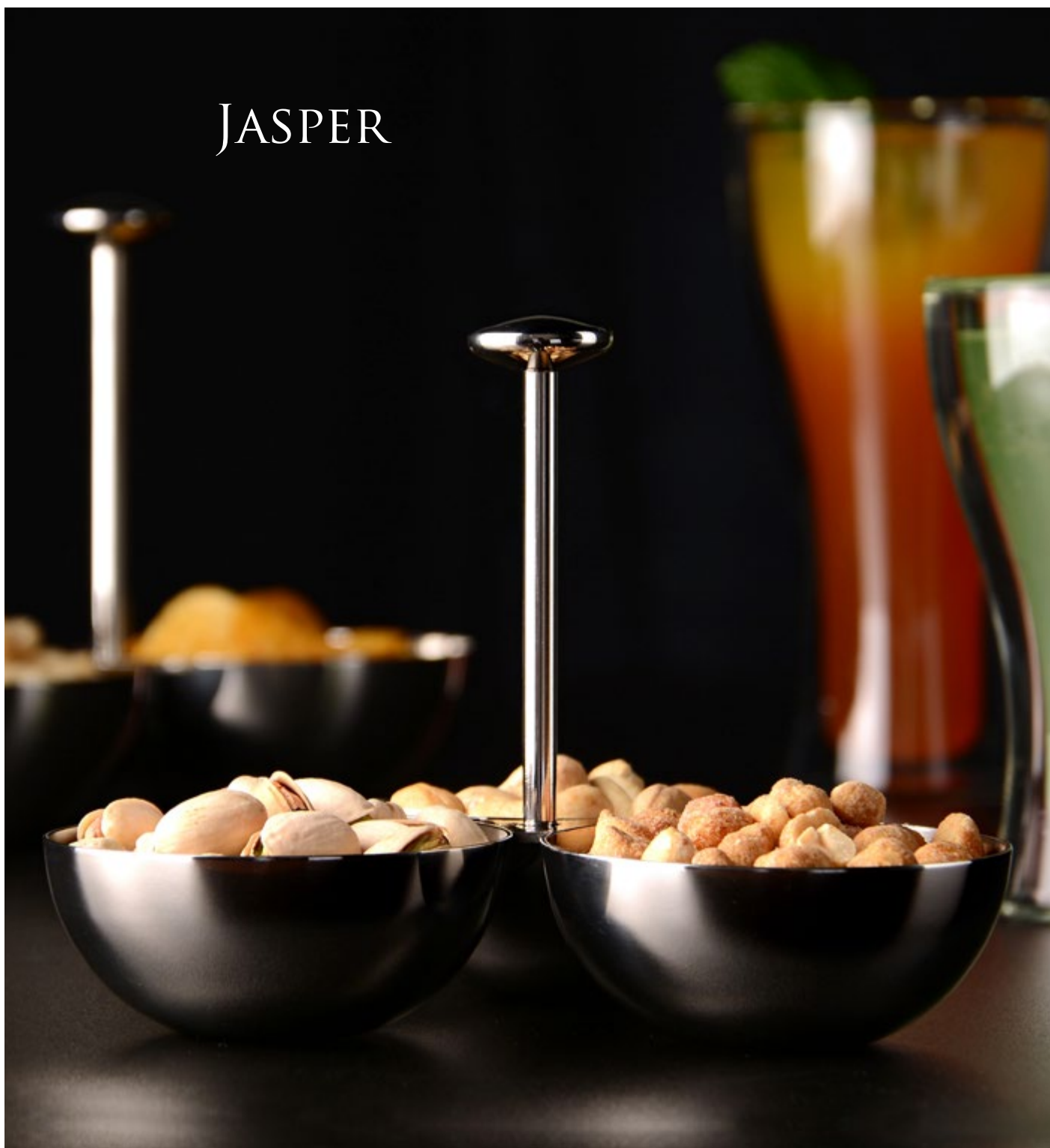

JASPER SNACK BOWLS

JASPER NAPKIN TRAY



TOP-72 / EACH BOWL: Ø70MM
OVERALL: 163×152×124(H)MM



TOP-71 / EACH BOWL: Ø100MM
OVERALL: 215×100×156(H)MM



TOP-75 / 175×166×140(H)MM
FOR NAPKIN SIZE UP TO 166×166MM

SWING



CHAMPAGNE COOLER STAND
(FIT BW.NM029 CHAMPAGNE COOLER)

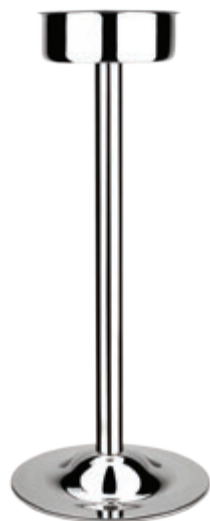

BW-017/ Ø185×685(H)MM

CHAMPAGNE COOLER

DOUBLE WALL



BW.NM029/ 4L

WINE COOLER

DOUBLE WALL



BW.NM030/ Ø120×210(H)MM

COCKTAIL SHAKER



BW.NM031/ 0.5L

ICE SERVING SET

DOUBLE WALL



BW.2.NM028/ 1.4L



ELEMENT

BASIC LINE FOR THE BUSY BARS.
YOU FIND ALL THE ESSENTIALS REQUIRED
BY PROFESSIONAL BARTENDERS.

CHAMPAGNE COOLER - TWO BOTTLES



BW-015L / 6L

CHAMPAGNE COOLER STAND
(FIT BW-015L CHAMPAGNE COOLER)



BW-017L / Ø205×685(H)MM



CHAMPAGNE COOLER STAND
(FIT BW-015 CHAMPAGNE COOLER)

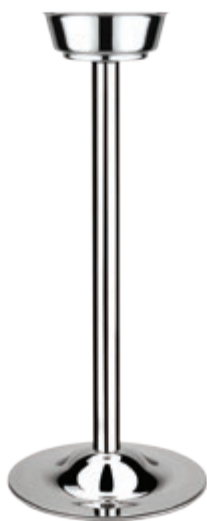

BW-017N/ Ø170×675(H)MM

CHAMPAGNE COOLER



BW-015/ 4L

WINE CRADLE



BW-024/ 98×252×255(H)MM

WINE COOLER

DOUBLE WALL



BW-033/ Ø120×190(H)MM

WINE COASTER



BW-025/ Ø125×10(H)MM

ELEMENT

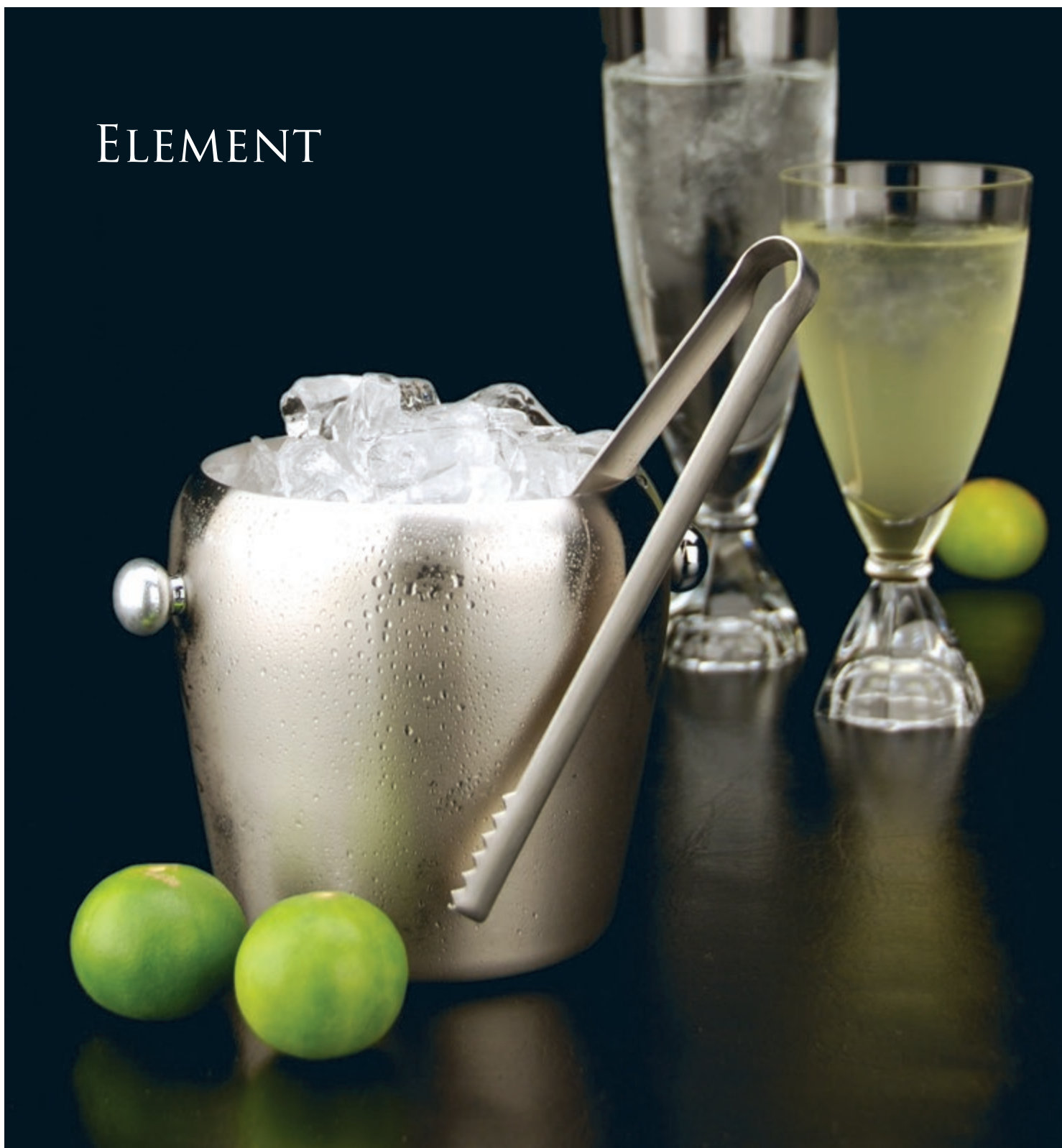

ICE BUCKET

ICE TONGS

COCKTAIL SHAKER

STRAINER

JIGGER



BW-011/ 1L



BW-006/ 176MM
BW-006S/ **DISCONTINUED**



BW-009/ 0.5L



BW-004



BW-008



STIRRER



848-ST/ 300MM

DELUXE CORKSCREW



BW-002 **DISCONTINUED**

WAITER CORKSCREW



BW-003 **DISCONTINUED**

CHAMPAGNE STOPPER



BW-001 **DISCONTINUED**

SERVICE

GREAT DESIGNS & HANDY TO USE -
ASSURING THE PERFECT SERVICE



RITZ CARAFE



GW-306.100/ Ø100x282(H)MM/ 1.0L

MARCUS CARAFE



GW-307.100/ **DISCONTINUED** 1.0L



GW-307.150/ **DISCONTINUED** 1.5L

RENAISSANCE
ICE WATER JUG



SWJ-19.1500/ 1.5L, H: 195MM

FUSION
ICE WATER JUG



SWJ-20.1500/ 1.5L, H:240MM

HORIZON
ICE WATER JUG



SWJ-22.1500/ 1.5L, H:315MM

RITZ SERVICE TRAY

W/ ANTI SLIP SILICON MAT IN BLACK

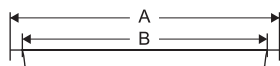

STR-01.38
A: Ø380MM B: Ø340MM
H:27MM

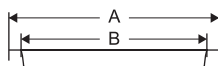

STR-01.32
A: Ø320MM B: Ø290MM
H:24MM

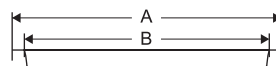

STR-01.38SI(BLK)
A: Ø380MM B: Ø340MM
H:27MM

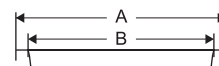

STR-01.32SI(BLK)
A: Ø320MM B: Ø290MM
H:24MM

IMPERIAL

INSULATED SERVERS
FEATURING UNBREAKABLE STAINLESS STEEL
LINER. VACUUMED TO PROVIDE REMARKABLE
INSULATION PERFORMANCE.



IMPERIAL INSULATED SERVER



IS-01.350/ **DISCONTINUED**



IS-01.650/ 0.65L



IS-01.1000/ 1.0L



IS-01.1500/ 1.5L

KYOTO WOODEN TRAY



TR-701-AS/ 353x160x54(H)MM

LEXI WOODEN TRAY



TR-1203-AS/ 325x194x50(H)MM



TR-1202-AS/ 325x325x50(H)MM

LEXI WOODEN TRAY



TR-1501-AS/ 460x360x58(H)MM



TR-1201-AS/ 550x355x58(H)MM

LEXI WOODEN TRAY



TR-1502-AS/ 660x460x58(H)MM

NEW

2



1

FEATURING:

- ① TS-001 LEXI TRAY STAND/ 420x420x820(H)MM
- ② TR-1502-AS LEXI WOODEN TRAY/ 660x460x58(H)MM



CAMEO

A DEDICATED DECORATION TO PRESENT TEA SET,
FRUIT OR EVEN SWEETS TO YOUR SPECIAL ROOM
GUEST.

CAMEO WOODEN BOX



- FEATURING:
- ❶ TR-20.182R WOODEN LID / Ø182 x 22(H)MM
 - ❷ BU-51 WOODEN BOWL / **DISCONTINUED**



- FEATURING:
- ❶ TR-20.252R WOODEN LID / Ø252 x 30(H)MM
 - ❷ BU-52 WOODEN BOWL / **DISCONTINUED**



- FEATURING:
- ❶ TR-20.300R WOODEN LID / Ø300 x 40(H)MM
 - ❷ BU-53 WOODEN BOWL / **DISCONTINUED**



NORDICA

NORDICA STAINLESS STEEL PLATE



BU-36/ Ø250×40(H)MM



BU-37/ Ø305×50(H)MM



BU-38 / Ø345 x 50(H)MM



GRAVY LADLE 806-GL/ 161MM	CAKE SERVER 806-KS/ 243MM	SERVING FORK 806-VF/ 232MM	SERVING SPOON 806-VS/ 232MM	SALAD FORK DISCONTINUED	SALAD SPOON DISCONTINUED	COCKTAIL/ SOUP LADLE 806-SL/ 290MM
------------------------------	------------------------------	-------------------------------	--------------------------------	-----------------------------------	------------------------------------	---------------------------------------



GRAVY LADLE 805-GL/ 168MM	CAKE SERVER 805-KS/ 240MM	SERVING FORK 805-VF/ 232MM	SERVING SPOON 805-VS/ 232MM	SALAD FORK DISCONTINUED	SALAD SPOON DISCONTINUED	COCKTAIL/ SOUP LADLE 805-SL/ 293MM
------------------------------	------------------------------	-------------------------------	--------------------------------	-----------------------------------	------------------------------------	---------------------------------------



GRAVY LADLE, OVAL BOWL 805-GLC/ 185MM	DRESSING LADLE, OVAL BOWL 805-DL/ 270MM	COCKTAIL/ SOUP LADLE, L 805-SLL/ 330MM	COCKTAIL LADLE, CLASSIC 805-CLC/ 415MM	BUFFET LADLE REST BU-46/Ø110x103(H)MM
---	---	--	--	--



BUFFET SPOON
BU-17/ 260MM



BUFFET SPOON,
SLOTTED
BU-17S/ 260MM



BUFFET SPOON, L
BU-17L/ 305MM



BUFFET SPOON, L
SLOTTED
BU-17LS/ 305MM



PASTRY TONGS
BU-18/ 200MM



PICKLE TONGS
BU-19/ 100MM



SCISSOR PASTRY
TONGS
BU-20/ 212MM



SCISSOR SALAD
TONGS
BU-21/ 212MM



SERVICE TONGS
BU-14/ 240MM

1



2



- 1 BUFFET TONGS REST
BU-47/ 150x72x29(H)MM
- 2 SERVING SPOON REST
BU-23/ 265x130x48(H)MM



NOTE





A large, solid gray rectangular area that serves as a background for the writing lines. It contains ten horizontal lines spaced evenly down the page, providing a guide for handwriting practice.









A large, solid gray rectangular area that serves as a background for the writing lines. It contains ten horizontal lines spaced evenly down the page, providing a guide for handwriting practice.





A large, solid gray rectangular area that serves as a background for the writing lines. It contains ten horizontal lines spaced evenly down the page, providing a guide for handwriting practice.





A large, solid gray rectangular area that serves as a background for the writing lines. It contains ten horizontal lines spaced evenly down the page, providing a guide for handwriting practice.





JOB REFERENCE



1	Address Boulevard Dubai	Dubai, UAE	51	Courtyard by Marriott Agra	Agra, India
2	Address Downtown Dubai	Dubai, UAE	52	Courtyard by Marriott Bangalore	Bangalore, India
3	Address Dubai Mall	Dubai, UAE	53	Courtyard by Marriott Beijing Northeast	Beijing, China
4	Address Dubai Marina	Dubai, UAE	54	Courtyard by Marriott Hong Kong Sha Tin	Hong Kong, China
5	Address Montgomerie Dubai	Dubai, UAE	55	Courtyard by Marriott Iloilo	Iloilo, Philippines
6	Alila Bangalore	Bangalore, India	56	Courtyard by Marriott Kochi Airport	Kochi, India
7	Alila Bangsar Kuala Lumpur	Kuala Lumpur, Malaysia	57	Courtyard by Marriott Raipur	Raipur, India
8	Alila Cha-am	Cha-am, Thailand	58	Courtyard by Marriott Siem Reap Resort	Siem Reap, Cambodia
9	Alila Diwa Goa	Goa, India	59	Crown Towers	Macau, China
10	Aloft Jakarta Wahid Hasyim	Jakarta, Indonesia	60	Crowne Plaza Beijing Wangfujing	Beijing, China
11	Aloft Kuala Lumpur Sentral	Kuala Lumpur, Malaysia	61	Crowne Plaza Changi Airport	Singapore
12	Altira Macau	Macau, China	62	Crowne Plaza Chengdu Panda Garden	Chengdu, China
13	Ambassador Hotel Hsinchu	Hsinchu, Taiwan	63	Crowne Plaza Dandong	Dandong, China
14	Ambassador Hotel Taipei	Taipei, Taiwan	64	Crowne Plaza Guangzhou Huadu	Guangzhou, China
15	Anantara Bali Uluwatu Resort & Spa	Bali, Indonesia	65	Crowne Plaza Guangzhou Science City	Guangzhou, China
16	Anantara Bangkok Sathorn	Bangkok, Thailand	66	Crowne Plaza Hefei	Hefei, China
17	Anantara Dhigu Maldives Resort	South Malé Atoll, Maldives	67	Crowne Plaza Hong Kong Causeway Bay	Hong Kong, China
18	Anantara Guiyang Resort & Spa	Guiyang, China	68	Crowne Plaza Hong Kong Kowloon East	Hong Kong, China
19	Anantara Hua Hin Resort & Spa	Hua Hin, Thailand	69	Crowne Plaza Lijiang Ancient Town	Lijiang, China
20	Anantara Kalutara Resort	Kalutara, Sri Lanka	70	Crowne Plaza Nanchang Riverside	Nanchang, China
21	Anantara Peace Haven Tangalle Resort	Tangalle, Sri Lanka	71	Crowne Plaza New Delhi Okhla	New Delhi, India
22	Anantara Qasr Al Sarab Desert Resort	Abu Dhabi, UAE	72	Crowne Plaza Shenyang Parkview	Shenyang, China
23	Atlantis the Palm	Dubai, UAE	73	Crowne Plaza Vientiane	Vientiane, Laos
24	Autograph Collection by Marriott - Boulevard Hotel Baku	Baku, Azerbaijan	74	Crowne Plaza Yas Island	Abu Dhabi, UAE
25	Autograph Collection by Marriott - Intourist Hotel Baku	Baku, Azerbaijan	75	Crowne Plaza Zhenjiang	Zhenjiang, China
26	Autograph Collection by Marriott - Stones Hotel Bali	Bali, Indonesia	76	Daemyung Resort Jeju	Jeju, South Korea
27	Banjaran Hotsprings Retreat	Perak, Malaysia	77	Disney Resort Shanghai	Shanghai, China
28	Banyan Tree Bangkok	Bangkok, Thailand	78	Double Tree by Hilton Agra	Agra, India
29	Banyan Tree Seychelles	Seychelles	79	Double Tree by Hilton Anshun	Anshun, China
30	Banyan Tree Macau	Macau, China	80	Double Tree by Hilton Guangzhou	Guangzhou, China
31	Bvlgari Resort Dubai	Dubai, UAE	81	Double Tree by Hilton Jiangsu Taizhou	Taizhou, China
32	Centara Grand at Central Plaza Ladprao Bangkok	Bangkok, Thailand	82	Double Tree by Hilton Sanya Haitang Bay	Sanya, China
33	Centara Grand West Sands Resort & Villas Phuket	Phuket, Thailand	83	Double Tree by Hilton Shenzhen Longhua	Shenzhen, China
34	Centara Pattaya Hotel	Pattaya, Thailand	84	Double Tree by Hilton Sukhumvit Bangkok	Bangkok, Thailand
35	Chateau Star River Guangzhou	Guangzhou, China	85	Double Tree by Hilton Xiamen	Xiamen, China
36	Chateau Star River Guangzhou Haiyi Peninsula	Guangzhou, China	86	Dusit D2 Nairobi	Nairobi, Kenya
37	Chateau Star River Shanghai Pudong	Shanghai, China	87	Dusit Devarana Hot Spring Hotel Conghua	Conghua, China
38	Chateau Star River Taiyuan	Taiyuan, China	88	Dusit Thani Hua Hin	Hua Hin, Thailand
39	Conrad Beijing	Beijing, China	89	Dusit Thani Maldives	Baa Atoll, Maldives
40	Conrad Bengaluru	Bangalore, India	90	Dusit Thani Manila	Manila, Philippines
41	Conrad Dalian	Dalian, China	91	Dusit Thani Pattaya	Pattaya, Thailand
42	Conrad Dubai	Dubai, UAE	92	Dusit Thani Bangkok	Bangkok, Thailand
43	Conrad Guangzhou	Guangzhou, China	93	East Beijing	Beijing, China
44	Conrad Hong Kong	Hong Kong, China	94	East Hong Kong	Hong Kong, China
45	Conrad Maldives Rangali Island	Rangali, Maldives	95	Eastin Grand Hotel Sathon Bangkok	Bangkok, Thailand
46	Conrad Manila	Manila, Philippines	96	Eastin Hotel Makkasan Bangkok	Bangkok, Thailand
47	Conrad Pune	Pune, India	97	Eastin Hotel Pattaya	Pattaya, Thailand
48	Conrad Sanya Haitang Bay	Sanya, China	98	Excelsior Hong Kong	Hong Kong, China
49	Conrad Seoul	Seoul, South Korea	99	Fairfield by Marriott Bali Legian	Bali, Indonesia
50	Conrad Xiamen	Xiamen, China	100	Fairfield by Marriott Bangalore	Bangalore, India

101	Fairmont Business Gate Riyadh	Riyadh, Saudi Arabia	151	Hilton Beijing Wangfujing	Beijing, China
102	Fairmont Jakarta	Jakarta, Indonesia	152	Hilton Busan	Busan, South Korea
103	Fairmont Makati	Manila, Philippines	153	Hilton Chengdu	Chengdu, China
104	Fairmont Peace Hotel	Shanghai, China	154	Hilton Colombo	Colombo, Sri Lanka
105	Fairmont The Palm Dubai	Dubai, UAE	155	Hilton Dalian	Dalian, China
106	Four Points by Sheraton Langfang Guan	Langfang, China	156	Hilton Garden Inn Bali Ngurah Rai Airport	Bali, Indonesia
107	Four Points by Sheraton Penghu	Penghu, Taiwan	157	Hilton Garden Inn Dubai	Dubai, UAE
108	Four Points by Sheraton Seoul Namsan	Seoul, South Korea	158	Hilton Grand Seoul	Seoul, South Korea
109	Four Points by Sheraton Sukhumvit 15	Bangkok, Thailand	159	Hilton Guangzhou Baiyun	Guangzhou, China
110	Four Points by Sheraton Sydney Darling Harbour	Sydney, Australia	160	Hilton Guangzhou Tianhe	Guangzhou, China
111	Four Seasons Hotel Bangkok	Bangkok, Thailand	161	Hilton Nanjing	Nanjing, China
112	Four Seasons Hotel Hong Kong	Hong Kong, China	162	Hilton Ningbo Chunxiao Hotel	Ningbo, China
113	Four Seasons Hotel Jakarta	Jakarta, Indonesia	163	Hilton Ningbo Dongqian Lake Resort	Ningbo, China
114	Four Seasons Hotel Mumbai	Mumbai, India	164	Hilton Pattaya	Pattaya, Thailand
115	Four Seasons Hotel Shenzhen	Shenzhen, China	165	Hilton Residences Bangalore	Bangalore, India
116	Four Seasons Hotel Singapore	Singapore	166	Hilton Residences Colombo	Colombo, Sri Lanka
117	Four Seasons Hotel Sydney	Sydney, Australia	167	Hilton Shenyang	Shenyang, China
118	Four Seasons Resort Dubai at Jumeirah Beach	Dubai, UAE	168	Hilton Shijiazhuang	Shijiazhuang, China
119	Four Seasons Resort Maldives at Kuda Huraa	Noordelijke Malé-atol, Maldives	169	Hilton Shillim Estate Retreat & Spa	Pune, India
120	Four Seasons Resort Maldives at Landaa Giraavaru	Baa Atoll, Maldives	170	Hilton Sukhumvit Bangkok	Bangkok, Thailand
121	Four Seasons Resort Seychelles	Seychelles	171	Hilton Sydney	Sydney, Australia
122	Fraser Place Robertson Walk Singapore	Singapore	172	Hilton Wuhan Riverside	Wuhan, China
123	Fraser Suites Chengdu	Chengdu, China	173	Hilton Xi'an	Xian, China
124	Fraser Suites Dalian	Dalian, China	174	Hilton Yantai	Yantai, China
125	Fraser Suites Nanjing	Nanjing, China	175	Hilton Zhongshan Downtown	Zhongshan, China
126	Fraser Suites River Valley Singapore	Singapore	176	Holiday Inn Bali	Bali, Indonesia
127	Fraser Suites Sukhumvit	Bangkok, Thailand	177	Holiday Inn Bangkok Sukhumvit 22	Bangkok, Thailand
128	Fullerton Bay Hotel	Singapore	178	Holiday Inn Chennai OMR IT Expressway	Chennai, India
129	Fullerton Hotel Singapore	Singapore	179	Holiday Inn Guangzhou City Centre	Guangzhou, China
130	Furama City Centre Singapore	Singapore	180	Holiday Inn Guangzhou Shifu	Guangzhou, China
131	Furama Silom	Bangkok, Thailand	181	Holiday Inn Incheon Songdo	Incheon, South Korea
132	Grand Hyatt Doha	Doha, Qatar	182	Holiday Inn Jaipur	Jaipur, India
133	Grand Hyatt Dubai	Dubai, UAE	183	Holiday Inn Muscat	Muscat, Oman
134	Grand Hyatt Incheon	Incheon, South Korea	184	Holiday Inn Pattaya	Pattaya, Thailand
135	Grand Hyatt Macau	Macau, China	185	Holiday Inn Resort Hainan Clear Water Bay	Lingshui, China
136	Grand Hyatt Sanya Haitang Bay Resort and Spa	Sanya, China	186	Holiday Inn Resort Regent Beach Cha-am	Cha-am, Thailand
137	Grand Hyatt Seoul	Seoul, South Korea	187	Holiday Inn Singapore Artium	Singapore
138	Grand Hyatt Taipei	Taipei, Taiwan	188	Holiday Inn Singapore Orchard City Centre	Singapore
139	Grand Mercure Fortune Bangkok	Bangkok, Thailand	189	Hualuxe Hotels & Resorts Haikou Seaview	Haikou, China
140	Grand Mercure Phuket Patong	Phuket, Thailand	190	Hyatt Regency Creek Dubai	Dubai, UAE
141	Grand Mercure Shanghai Zhongya	Shanghai, China	191	Hyatt Regency Delhi	New Delhi, India
142	Grand Mercure Zhengzhou West	Zhengzhou, China	192	Hyatt Regency Dubai	Dubai, UAE
143	Grand Millennium Al Wahda	Abu Dhabi, UAE	193	Hyatt Regency Guam	Tamuning, Guam
144	Grand Millennium Dubai	Dubai, UAE	194	Hyatt Regency Hua Hin	Hua Hin, Thailand
145	Hard Rock Hotel Bali	Bali, Indonesia	195	Hyatt Regency Jeju	Jeju, South Korea
146	Hard Rock Hotel Macau	Macau, China	196	Hyatt Regency Pune	Pune, India
147	Hard Rock Hotel Shenzhen	Shenzhen, China	197	Hyatt Regency Riyadh	Riyadh, Saudi Arabia
148	Harris Vertu Hotel Harmoni Jakarta	Jakarta, Indonesia	198	Indigo Hotel Bali Seminyak Beach	Bali, Indonesia
149	Hilton Bangalore Embassy GolfLinks	Bangalore, India	199	InterContinental Guangzhou Exhibition Center	Guangzhou, China
150	Hilton Beijing Capital Airport	Beijing, China	200	InterContinental Hotels Abu Dhabi	Abu Dhabi, UAE

201	InterContinental Hotels Century City Chengdu	Chengdu, China	251	Kempinski Hotel Indonesia Jakarta	Jakarta, Indonesia
202	InterContinental Hotels Doha	Doha, Qatar	252	Kempinski Residences & Suites Doha	Doha, Qatar
203	InterContinental Hotels Festival City	Dubai, UAE	253	Kempinski The Heritage Yangon	Yangon, Myanmar
204	InterContinental Hotels Foshan	Foshan, China	254	Kempinski Villa Rosa Nairobi	Nairobi, Kenya
205	InterContinental Hotels Grand Seoul Parnas	Seoul, South Korea	255	Lalu Hotel Qingdao	Qingdao, China
206	InterContinental Hotels Hanoi Landmark	Hanoi, Vietnam	256	Lalu Hotel Sun Moon Lake	Nantou, Taiwan
207	InterContinental Hotels Hong Kong	Hong Kong, China	257	Langham Hong Kong	Hong Kong, China
208	InterContinental Hotels Hua Hin Resort	Hua Hin, Thailand	258	Langham Place Guangzhou	Guangzhou, China
209	InterContinental Hotels Johannesburg Airport	Johannesburg, South Africa	259	Langham Place Samui	Koh Samui, Thailand
210	InterContinental Hotels Kuala Lumpur	Kuala Lumpur, Malaysia	260	Langham Place Xiamen	Xiamen, China
211	InterContinental Hotels Marine Drive Mumbai	Mumbai, India	261	Le Meridien Chiang Mai	Chiang Mai, Thailand
212	InterContinental Hotels Phnom Penh	Phnom Penh, Cambodia	262	Le Meridien Coimbatore	Coimbatore, India
213	InterContinental Hotels Sandton Towers	Johannesburg, South Africa	263	Le Meridien Cyberport	Hong Kong, China
214	InterContinental Hotels Seoul COEX	Seoul, South Korea	264	Le Meridien Dubai Hotel & Conference Centre	Dubai, UAE
215	InterContinental Hotels Shanghai NECC	Shanghai, China	265	Le Meridien Jakarta	Jakarta, Indonesia
216	InterContinental Hotels Shanghai Puxi	Shanghai, China	266	Le Meridien Mahabaleshwar	Mahabaleshwar, India
217	InterContinental Hotels Singapore	Singapore	267	Le Meridien Mina Seyahi Beach Resort & Marina	Dubai, UAE
218	InterContinental Hotels Singapore Robertson Quay	Singapore	268	Le Meridien Pune	Pune, India
219	InterContinental Hotels Sydney	Sydney, Australia	269	Le Meridien Saigon	Ho Chi Minh City, Vietnam
220	InterContinental Resort Bali	Bali, Indonesia	270	Le Meridien Shenyang Heping Hotel	Shenyang, China
221	InterContinental Resort Fujairah	Fujairah, UAE	271	Le Meridien Sheshan Shanghai Hotel	Shanghai, China
222	Jinling Hotel Nanjing	Nanjing, China	272	Le Meridien Suvarnabhumi Bangkok Golf Resort & Spa	Bangkok, Thailand
223	Jinling Hotel Taizhou	Taizhou, China	273	Le Meridien Taipei	Taipei, Taiwan
224	Jinling Hotel Wuxi	Wuxi, China	274	Le Meridien Xi'an Chanba Hotel	Xian, China
225	Jinling Hotel Yangzhou	Yangzhou, China	275	Le Meridien Yixing	Yixing, China
226	Jumeirah Beach Hotel - Dubai	Dubai, UAE	276	Le Royal Meridien Beach Resort & Spa	Dubai, UAE
227	Jumeirah Creekside Hotel - Dubai	Dubai, UAE	277	Le Royal Meridien Plaza Athénée Bangkok	Bangkok, Thailand
228	Jumeirah Hotel - Souk Madinat	Dubai, UAE	278	Le Royal Meridien Shanghai Hotel	Shanghai, China
229	Jumeirah Hotel - Al Qasr	Dubai, UAE	279	Lebua Hotels and Resorts Thailand	Bangkok, Thailand
230	Jumeirah Hotel - Burj Al Arab	Dubai, UAE	280	Luxury Collection Hotel Keraton at The Plaza	Jakarta, Indonesia
231	Jumeirah Hotel - Emirates Towers	Dubai, UAE	281	Luxury Collection Hotel The Azure Qiantang	Hangzhou, China
232	Jumeirah Hotel - Golf Estates	Dubai, UAE	282	Mandarin Oriental Guangzhou	Guangzhou, China
233	Jumeirah Hotel - Madinat Jumeirah	Dubai, UAE	283	Mandarin Oriental Hong Kong	Hong Kong, China
234	Jumeirah Hotel - Mina A Salam	Dubai, UAE	284	Mandarin Oriental Macau	Macau, China
235	Jumeirah Hotel - Phase IV	Dubai, UAE	285	Mandarin Oriental Pudong Shanghai	Shanghai, China
236	Jumeirah Hotel - Rotana Dubai	Dubai, UAE	286	Mandarin Oriental Singapore	Singapore
237	JW Marriott Hotel Bangkok	Bangkok, Thailand	287	Marco Polo Jinjiang	Jinjiang, China
238	JW Marriott Hotel Chengdu	Chengdu, China	288	Marco Polo Xiamen	Xiamen, China
239	JW Marriott Hotel Hanoi	Hanoi, Vietnam	289	Marina Bay Sands Singapore	Singapore
240	JW Marriott Hotel Hong Kong	Hong Kong, China	290	Marriott Hotel Airport Road Abu Dhabi	Abu Dhabi, UAE
241	JW Marriott Hotel Kolkata	Kolkata, India	291	Marriott Hotel Al Forsan	Abu Dhabi, UAE
242	JW Marriott Hotel Marquis Dubai	Dubai, UAE	292	Marriott Hotel Changzhou	Changzhou, China
243	JW Marriott Hotel Shenzhen	Shenzhen, China	293	Marriott Hotel Downtown AUH	Abu Dhabi, UAE
244	JW Marriott Hotel Jakarta	Jakarta, Indonesia	294	Marriott Hotel Financial Centre Chengdu	Chengdu, China
245	JW Marriott Khao Lak Resort & Spa	Takuapa, Thailand	295	Marriott Hotel Guangzhou Tianhe	Guangzhou, China
246	JW Marriott Mumbai Sahar	Mumbai, India	296	Marriott Hotel Haikou	Haikou, China
247	JW Marriott Mussoorie Walnut Grove Resort & Spa	Mussoorie, India	297	Marriott Hotel Indore	Indore, India
248	Kempinski Ajman	Ajman, UAE	298	Marriott Hotel Jixian	Tianjin, China
249	Kempinski Djibloho Grand Hotel	Oyala, Equatorial Guinea	299	Marriott Hotel Kigali	Kigali, Rwanda
250	Kempinski Grand Hotel Shanghai	Shanghai, China	300	Marriott Hotel Manila Grand Ballroom	Manila, Philippines

301	Marriott Hotel Marquis Queen's Park	Bangkok, Thailand	351	Novotel Bangalore Techpark	Bangalore, India
302	Marriott Hotel Nanjing South	Nanjing, China	352	Novotel Bangkok Platinum	Bangkok, Thailand
303	Marriott Hotel Ocean Park Hong Kong	Hong Kong, China	353	Novotel Bangkok Ploenchit Sukhumvit	Bangkok, Thailand
304	Marriott Hotel Sanya	Sanya, China	354	Novotel Dubai Al Barsha	Dubai, UAE
305	Marriott Hotel Sukhumvit	Bangkok, Thailand	355	Novotel Halong Bay	Ha Long, Vietnam
306	Marriott Hotel Taipei	Taipei, Taiwan	356	Novotel Hong Kong Citygate	Hong Kong, China
307	Marriott Hotel Tang Plaza Singapore	Singapore	357	Novotel Hyderabad	Hyderabad, India
308	Marriott Hotel Yiwu	Yiwu, China	358	Novotel Jakarta Mangga Dua Square	Jakarta, Indonesia
309	Marriott Mayfair Bangkok Executive Apartments	Bangkok, Thailand	359	Novotel Kolkata Hotel and Residences	Kolkata, India
310	Marriott Resort & Spa Hotel Merlin Beach	Phuket, Thailand	360	Novotel Lampung	Bandar Lampung, Indonesia
311	Marriott Resort & Spa Hotel Pattaya	Pattaya, Thailand	361	Novotel Manila Araneta Center	Manila, Philippines
312	Maximilan by Steigenberger Beijing	Beijing, China	362	Novotel Nusa Dua Bali	Bali, Indonesia
313	Mercure Hyderabad	Hyderabad, India	363	Novotel Pekanbaru	Pekanbaru, Indonesia
314	MGM Cotai Macau	Macau, China	364	Novotel Phu Quoc Resort	Phu Quoc, Vietnam
315	Millennium Airport Road Hotel Dubai	Dubai, UAE	365	Novotel Singapore on Stevens	Singapore
316	Millennium Hilton Hotel Bangkok	Bangkok, Thailand	366	Novotel Taipei Taoyuan International Airport	Taipei, Taiwan
317	Millennium New World Hotel Hong Kong	Hong Kong, China	367	Novotel Visakhapatnam Varun Beach	Visakhapatnam, India
318	Millennium Plaza Hotel Dubai	Dubai, UAE	368	Novotel World Trade Centre Dubai	Dubai, UAE
319	Mira Moon Hotel	Hong Kong, China	369	Oberoi Ajman	Ajman, UAE
320	Mondrian Hotel Doha	Doha, Qatar	370	Oberoi Dubai	Dubai, UAE
321	Morpheus Hotel	Macau, China	371	Oberoi New Delhi	New Delhi, India
322	Mövenpick Heritage Hotel Sentosa	Singapore	372	Oberoi Trident Hotel Mumbai	Mumbai, India
323	Mövenpick Hotel & Spa Bangalore	Bangalore, India	373	Octave Sangha Retreat	Suzhou, China
324	Mövenpick Hotel Colombo	Colombo, Sri Lanka	374	Okura Prestige Bangkok	Bangkok, Thailand
325	Mövenpick Hotel Ibn Battuta Gate Hotel Dubai	Dubai, UAE	375	Okura Prestige Taipei	Taipei, Taiwan
326	Mövenpick Hotel Jumeirah Beach	Dubai, UAE	376	Pan Pacific Beijing	Beijing, China
327	Mövenpick Hotel Siam Hotel Pattaya	Pattaya, Thailand	377	Pan Pacific Hotel and Serviced Suites Tianjin	Tianjin, China
328	Mövenpick Hotel Sukhumvit 15 Bangkok	Bangkok, Thailand	378	Pan Pacific Orchard Singapore	Singapore
329	Mövenpick Resort & Spa Boracay	Boracay, Philippines	379	Pan Pacific Serviced Suites Bangkok	Bangkok, Thailand
330	Mövenpick Resort & Spa Jimbaran Bali	Bali, Indonesia	380	Pan Pacific Serviced Suites Beach Road Singapore	Singapore
331	New World Beijing Hotel	Beijing, China	381	Pan Pacific Singapore	Singapore
332	New World Dalian Hotel	Dalian, China	382	Pan Pacific Yangon	Yangon, Myanmar
333	New World Guiyang Hotel	Guiyang, China	383	Paradise City Incheon	Incheon, South Korea
334	New World Langfang Hotel	Langfang, China	384	Paradise Hotel Busan	Busan, South Korea
335	New World Makati Hotel	Manila, Philippines	385	Parisian Macao	Macau, China
336	New World Manila Bay	Manila, Philippines	386	Park Hyatt Dubai	Dubai, UAE
337	New World Petaling Jaya Hotel	Petaling Jaya, Malaysia	387	Park Hyatt Maldives Hadahaa	Hadahaa, Maldives
338	New World Saigon Hotel	Ho Chi Minh City, Vietnam	388	Park Inn by Radisson Clark	Angeles, Philippines
339	New World Shanghai Hotel	Shanghai, China	389	Parkroyal on Pickering Singapore	Singapore
340	New World Shenyang Hotel	Shenyang, China	390	Parkroyal Penang Resort	Penang, Malaysia
341	Niccolo Hotel Chengdu	Chengdu, China	391	Peninsula Hotel Manila	Manila, Philippines
342	Niccolo Hotel Chongqing	Chongqing, China	392	Penta Hotel Beijing	Beijing, China
343	Niccolo Hotel The Murray Hong Kong	Hong Kong, China	393	Penta Hotel Hong Kong Kowloon	Hong Kong, China
344	Novotel Abu Dhabi Al Bustan	Abu Dhabi, UAE	394	Penta Hotel Hong Kong Tuen Mun	Hong Kong, China
345	Novotel Abu Dhabi Gate	Abu Dhabi, UAE	395	Pullman Ambassador Changwon City 7	Seoul, South Korea
346	Novotel Ambassador Doksan	Seoul, South Korea	396	Pullman Danang Beach Resort	Danang City, Vietnam
347	Novotel Ambassador Seoul Gangnam	Seoul, South Korea	397	Pullman Hanoi	Hanoi, Vietnam
348	Novotel Ambassador Suwon	Suwon, South Korea	398	Pullman Hotel Park Lane Hong Kong	Hong Kong, China
349	Novotel Bali Ngurah Rai Airport	Bali, Indonesia	399	Pullman Jakarta Central Park	Jakarta, Indonesia
350	Novotel Bali Nusa Dua	Bali, Indonesia	400	Pullman Jakarta Indonesia Thamrin CBD	Jakarta, Indonesia

401	Pullman Oceanview Sanya Bay Resort & Spa	Sanya, China	451	Rotana Al Murooj	Dubai, UAE
402	Pullman Pattaya Aisawan	Pattaya, Thailand	452	Rotana Amwaj - Jumeirah Beach Residence	Dubai, UAE
403	Pullman Saigon Centre	Ho Chi Minh City, Vietnam	453	Rotana Art Amwaj Island	Manama, Bahrain
404	Pullman Sanya Yalong Bay	Sanya, China	454	Rotana Beach Abu Dhabi	Abu Dhabi, UAE
405	Pullman Weifang	Weifang, China	455	Rotana Burjuman Arjaan	Dubai, UAE
406	Pullman Wuxi New Lake	Wuxi, China	456	Rotana Capital Centre Arjaan	Abu Dhabi, UAE
407	Radisson Blu Bali Uluwatu	Bali, Indonesia	457	Rotana Centro Doha Al Malkhi RE	Doha, Qatar
408	Radisson Blu Hotel GRT Chennai	Chennai, India	458	Rotana Centro Shaheen Jeddah	Jeddah, Saudi Arabia
409	Radisson Blu Plaza Chongqing	Chongqing, China	459	Rotana Cove RAK	Ras Al Kaimah, UAE
410	Radisson Blu Plaza Delhi Airport	New Delhi, India	460	Rotana Downtown Bahrain	Manama, Bahrain
411	Radisson Blu Plaza Mumbai Powai	Mumbai, India	461	Rotana Fujairah	Fujairah, UAE
412	Radisson Suites Bangkok Sukhumvit	Bangkok, Thailand	462	Rotana Khalidiya Palace Rayhaan AUH	Abu Dhabi, UAE
413	Raffles Dubai	Dubai, UAE	463	Rotana Media Dubai	Dubai, UAE
414	Raffles Hainan	Sanya, China	464	Rotana Oryx Doha	Doha, Qatar
415	Raffles Jakarta	Jakarta, Indonesia	465	Rotana Pearl Capital Centre	Abu Dhabi, UAE
416	Raffles Le Royal	Phnom Penh, Cambodia	466	Rotana Rayhaan Hili	Abu Dhabi, UAE
417	Ramada Downtown Dubai	Dubai, UAE	467	Rotana Rose Rayhaan Dubai	Dubai, UAE
418	Ramada Plaza Palm Grove Juhu Beach	Mumbai, India	468	Rotana Rosh Rayhaan KSA	Riyadh, Saudi Arabia
419	Ramada Plaza Suwon	Suwon, South Korea	469	Rotana Saadiyat Resorts & Villas	Abu Dhabi, UAE
420	Ramada Plaza Wenan	Langfang, China	470	Rotana Towers Dubai	Dubai, UAE
421	Ramada Singapore at Zhongshan Park	Singapore	471	Rotana Yas Island	Dubai, UAE
422	Regal Airport Hotel	Hong Kong, China	472	Sands Macao	Macao, China
423	Regal Hong Kong Hotel	Hong Kong, China	473	Seamarq Hotel Gangneung	Gangneung, South Korea
424	Regal Riverside Hotel	Hong Kong, China	474	Sentosa Resorts World Singapore	Singapore
425	Regent Taipei	Taipei, Taiwan	475	Shangri-La at The Fort	Manila, Philippines
426	Renaissance Bangkok Ratchaprasong Hotel	Bangkok, Thailand	476	Shangri-La Bangalore	Bangalore, India
427	Renaissance Harbour View Hong Kong Hotel	Hong Kong, China	477	Shangri-La Edsa	Manila, Philippines
428	Renaissance Haikou Mission Hills Hotel	Haikou, China	478	Shangri-La Hong Kong Island	Hong Kong, China
429	Renaissance Lucknow Hotel	Lucknow, India	479	Shangri-La Hong Kong Kowloon	Hong Kong, China
430	Renaissance Mumbai Convention Centre Hotel	Mumbai, India	480	Shangri-La Hotel Dubai	Dubai, UAE
431	Renaissance Xi'an Hotel	Xian, China	481	Shangri-La Hotel Sanya	Sanya, China
432	Ritz-Carlton Bali	Bali, Indonesia	482	Shangri-La Hotel Singapore	Singapore
433	Ritz-Carlton Doha	Doha, Qatar	483	Shangri-La Hotel Suzhou	Suzhou, China
434	Ritz-Carlton Dubai	Dubai, UAE	484	Shangri-La Hotel Sydney	Sydney, Australia
435	Ritz-Carlton Dubai International Financial Centre	Dubai, UAE	485	Shangri-La Hotel Tianjin	Tianjin, China
436	Ritz-Carlton Guangzhou	Guangzhou, China	486	Shangri-La Manila	Manila, Philippines
437	Ritz-Carlton Haikou	Haikou, China	487	Shangri-La's Far Eastern Plaza Hotel	Taipei, Taiwan
438	Ritz-Carlton Hong Kong	Hong Kong, China	488	Shangri-La's Hambantota Resort & Spa	Ambalantota, Sri Lanka
439	Ritz-Carlton Jakarta Pacific Place	Jakarta, Indonesia	489	Shangri-La's Rasa Sentosa Resort & Spa Singapore	Singapore
440	Ritz-Carlton Reserve Mandapa	Bali, Indonesia	490	Sheraton Bali Kuta Resort	Bali, Indonesia
441	Ritz-Carlton Reserve Phulay Bay	Krabi, Thailand	491	Sheraton Changchun Jingyuetan Hotel	Changchun, China
442	Ritz-Carlton South Beach	Miami, US	492	Sheraton Changzhou Xinbei Hotel	Changzhou, China
443	Roosevelt Hotel Macau - A Modern Hollywood Revival	Macau, China	493	Sheraton Grand Bangalore Hotel at Brigade Gateway	Bangalore, India
444	Rosewood Hotel Abu Dhabi UAE	Abu Dhabi, UAE	494	Sheraton Grand Danang Resort	Danang City, Vietnam
445	Rosewood Hotel Beijing	Beijing, China	495	Sheraton Grand Incheon Hotel	Incheon, South Korea
446	Rosewood Hotel Dai Pai Dong	Abu Dhabi, UAE	496	Sheraton Grand Macao Hotel Cotai Central	Macao, China
447	Rosewood Hotel Sanya	Sanya, China	497	Sheraton Grande Taipei Hotel	Taipei, Taiwan
448	Rotana Al Bandar	Dubai, UAE	498	Sheraton Guangzhou Hotel	Guangzhou, China
449	Rotana Al Ghurair Rayjaan	Dubai, UAE	499	Sheraton Guangzhou Nansha Hotel	Guangzhou, China
450	Rotana Al Maha Arjaan	Dubai, UAE	500	Sheraton Guiyang Hotel	Guiyang, China

501	Sheraton Hsinchu Hotel	Hsinchu, Taiwan	551	The Trans Luxury Hotel	Bali, Indonesia
502	Sheraton Hua Hin Resort & Spa	Hua Hin, Thailand	552	Tiger Resort Manila Bay	Manila, Philippines
503	Sheraton Krabi Beach Resort	Krabi, Thailand	553	Venetian Macao Resort Hotel	Macao, China
504	Sheraton Maldives Full Moon Resort & Spa	Furanafushi, Maldives	554	Vivanta by Taj - Begumpet Hyderabad	Hyderabad, India
505	Sheraton Nha Trang Hotel & Spa	Nha Trang, Vietnam	555	Vivanta by Taj - Fishermans Cove	Chennai, India
506	Sheraton Oman Hotel	Muscat, Oman	556	Vivanta by Taj - Gomti Nagar Lucknow	Lucknow, India
507	Sheraton Petaling Jaya Hotel	Selangor, Malaysia	557	Vivanta by Taj - Green Cove Kovalam	Kovalam, India
508	Sheraton Saigon Hotel & Towers	Ho Chi Minh City, Vietnam	558	Vivanta by Taj - Gurgaon	Gurgaon, India
509	Sheraton Samui Resort	Koh Samui, Thailand	559	Vivanta by Taj - Guwahati	Guwahati, India
510	Sheraton Shanghai Hongqiao Hotel	Shanghai, China	560	Vivanta by Taj - Madikeri Coorg	Coorg, India
511	Sheraton Sharjah Hotel	Sharjah, UAE	561	Vivanta by Taj - MG Road Bangalore	Bangalore, India
512	Sheraton Shenzhen Futian Hotel	Shenzhen, China	562	Vivanta by Taj - President Mumbai	Mumbai, India
513	Sheraton Wuhan Hotel	Wuhan, China	563	Vivanta by Taj - Sawai Madhopur	Sawai Madhopur, India
514	Sheraton Zhengzhou Hotel	Zhengzhou, China	564	Vivanta by Taj - Surya Coimbatore	Coimbatore, India
515	Sheraton Zhenjiang Hotel	Zhenjiang, China	565	Vivanta by Taj - Whitefield Bangalore	Bangalore, India
516	Sheraton Zhuhai Hotel	Zhuhai, China	566	Vivanta by Taj - Yeshwantpur Bangalore	Bangalore, India
517	Sofitel Dubai Downtown Hotel	Dubai, UAE	567	W Bangkok	Bangkok, Thailand
518	Sofitel Dubai The Palm Resort & Spa	Dubai, UAE	568	W Goa	Goa, India
519	Sofitel Foshan	Foshan, China	569	W Guangzhou	Guangzhou, China
520	Sofitel Guiyang	Guiyang, China	570	W Hong Kong	Hong Kong, China
521	Sofitel Macau at Ponte 16	Macao, China	571	W Dubai	Dubai, UAE
522	Sofitel Mumbai BKC	Mumbai, India	572	W Seoul Walkerhill	Seoul, South Korea
523	Sofitel Philippine Plaza Manila	Manila, Philippines	573	W Taipei	Taipei, Taiwan
524	Sofitel Qingyuan Riverside	Qingyuan, China	574	W Xi'an	Xian, China
525	Sofitel Sanya Leeman Resort	Sanya, China	575	Wanda Hotels & Resorts Chifeng	Chifeng, China
526	Sofitel Shanghai Hongqiao	Shanghai, China	576	Wanda Realm Hotel Bengbu	Bengbu, China
527	Sofitel Singapore Sentosa Resort & Spa	Singapore	577	Wanda Realm Hotel Jinhua	Jinhua, China
528	Sofitel So Bangkok	Bangkok, Thailand	578	Wanda Realm Hotel Wuhu	Wuhu, China
529	Sofitel Wanda Chengdu	Chengdu, China	579	Wanda Vista Hotel Nanning	Nanning, China
530	Sofitel Kunming	Kunming, China	580	Wanda Vista Hotel Shenyang	Shenyang, China
531	Sokha Beach Resort	Sihanoukville, Cambodia	581	Waterfront Manila Pavilion Hotel & Casino	Manila, Philippines
532	St. Regis Dubai	Dubai, UAE	582	Westin Grande Sukhumvit	Bangkok, Thailand
533	St. Regis Macao	Macao, China	583	Westin Guangzhou	Guangzhou, China
534	St. Regis Maldives Vommuli Resort	Dhaalu Atoll, Maldives	584	Westin Haikou	Haikou, China
535	St. Regis Mumbai	Mumbai, India	585	Westin Hyderabad Mindspace	Hyderabad, India
536	St. Regis Saadiyat Island	Abu Dhabi, UAE	586	Westin Jakarta	Jakarta, Indonesia
537	St. Regis Sanya Yalong Bay Resort	Sanya, China	587	Westin Mina Seyahi	Dubai, UAE
538	St. Regis Shenzhen	Shenzhen, China	588	Westin Mumbai Garden City	Mumbai, India
539	St. Regis Singapore	Singapore	589	Westin Pazhou	Guangzhou, China
540	Studio City Macau	Macao, China	590	Westin Resort Nusa Dua Bali	Bali, Indonesia
541	Swissotel Le Concorde	Bangkok, Thailand	591	Westin Shenzhen Nanshan	Shenzhen, China
542	Swissotel Merchant Court	Singapore	592	Westin Taipei	Taipei, Taiwan
543	Swissotel Nai Lert Park	Bangkok, Thailand	593	Westin Tashee Resort, Taoyuan	Taoyuan, Taiwan
544	Swissotel The Stamford	Singapore	594	Wyndham Dubai Marina	Dubai, UAE
545	Taj Coromandel	Chennai, India	595	Wyndham Grand Shenzhen	Shenzhen, China
546	Taj Exotica Resort & Spa Andamans	Andaman, India	596	Wyndham Grand Xiamen	Xiamen, China
547	Taj Falaknuma Palace	Hyderabad, India	597	Wyndham Grand Xiamen Haicang	Xiamen, China
548	Taj Lands End	Mumbai, India	598	Wyndham Grand Xi'an Residence	Xian, China
549	Taj Samudra Hotel	Colombo, Sri Lanka	599	Wyndham Sanya Bay	Sanya, China
550	Temple House	Chengdu, China	600	Wynn Palace Macau	Macao, China

ATHENA[®]

DISTRIBUTED BY :



ATHENA TABLEWARE UK LTD.
27 Clay Hill Road, Sleaford, Lincolnshire,
UK NG 34 7TF, The U.K.

Hotline: (+44) 844 247 5490
info@athena-tableware.com

www.athena-tableware.com



